





ENGLISH

User manual



TABLE OF CONTENTS

1. PRECAUTIONS AND SAFETY MEASURES	2
1.1. Preliminary instructions	2
1.2. During use	3
1.3. After use	3
1.4. Definition of Measurement (Overvoltage) category	3
2. GENERAL DESCRIPTION	4
2.1. Measuring average values and TRMS values	4
2.2. Definition of true root mean square value and Crest factor	4
3. PREPARATION FOR USE	5
3.1. Initial checks	5
3.2. Instrument power supply	5
3.3. Storage	5
4. NOMENCLATURE	6
4.1. Description of the instrument	6
4.1.1. Instrument's initial screen	6
4.2. Description of function keys	7
4.2.1. Key GO/HOLD	7
4.2.2. Key H/H%/H 	7
4.2.3. Key MODE/MXMNPK	8
4.2.4. Keys  /  and 	8
4.2.5. Key RCDIΔN/ 	8
4.2.6. LoZ function	9
4.2.7. AC+DC function	9
4.2.8. Inrush current function (INRUSH)	9
4.2.9. Disabling the Auto Power Off function	9
4.2.10. Setting the contact voltage limit	9
4.2.11. Setting the rated voltage in Loop/Ra measurement	10
4.2.12. Setting full scale of flexible clamp	10
5. OPERATING INSTRUCTIONS	11
5.1. DC voltage measurement	11
5.2. AC, AC+DC voltage measurement	12
5.3. AC, DC, AC+DC voltage with low impedance (LoZ)	13
5.4. Resistance measurement and continuity test	14
5.5. Phase sequence and phase concordance with 1 terminal	15
5.6. Overall earth resistance without RCD tripping	17
5.7. Measurement of Line/Loop impedance	20
5.8. Test on A and AC RCDs	24
5.9. DC, AC, AC+DC, INRUSH current with clamp transducers	29
6. MAINTENANCE	33
6.1. Battery replacement	33
6.2. Cleaning the instrument	33
6.3. End of life	33
7. TECHNICAL SPECIFICATIONS	34
7.1. Technical characteristics	34
7.1.1. General characteristics	36
7.2. Environmental conditions for use	36
7.3. Accessories	36
8. ASSISTANCE	37
8.1. Warranty conditions	37
8.2. Assistance	37
9. THEORETICAL APPENDIXES	38
9.1. Test on differential switches (RCD)	38
9.2. Overall earth resistance in TT systems	39
9.3. Loop and calculation of assumed short-circuit current	40
9.4. Voltage and current harmonics	41

1. PRECAUTIONS AND SAFETY MEASURES

The instrument has been designed in compliance with directive IEC/EN61010-1 relevant to electronic measuring instruments. For your safety and in order to prevent damaging the instrument, please carefully follow the procedures described in this manual and read all notes preceded by symbol  with the utmost attention.

Before and after carrying out measurements, carefully observe the following instructions:

- Do not carry out any measurement in humid environments.
- Do not carry out any measurements in case gas, explosive materials or flammables are present, or in dusty environments.
- Avoid any contact with the circuit being measured if no measurements are being carried out.
- Avoid any contact with exposed metal parts, with unused measuring probes, etc.
- Do not carry out any measurement in case you find anomalies in the instrument such as deformation, breaks, substance leaks, absence of display on the screen, etc.
- Pay special attention when measuring voltages higher than 20V, since a risk of electrical shock exists.

In this manual, and on the instrument, the following symbols are used:



Warning: observe the instructions given in this manual; improper use could damage the instrument or its components.



High voltage danger: electrical shock hazard.



Double-insulated meter



AC voltage or current



DC voltage or current



Connection to earth

1.1. PRELIMINARY INSTRUCTIONS

- This instrument has been designed for use in environments of pollution degree 2.
- It can be used for **VOLTAGE** and **CURRENT** measurements on installations with CAT IV 600V, CAT III 690V to earth and between inputs.
- We recommend following the normal safety rules devised by the procedures for carrying out operations on live systems and using the prescribed PPE to protect the user against dangerous currents and the instrument against incorrect use.
- In case the lack of indication of the presence of voltage may represent a danger for the operator, always carry out a continuity measurement before carrying out the measurement on the live system, in order to confirm the correct connection and condition of the leads.
- Only the leads supplied with the instrument guarantee compliance with the safety standards. They must be in good conditions and replaced, if necessary, exclusively with HT original accessories.
- Do not test circuits exceeding the specified voltage limits.
- Do not perform any test under environmental conditions exceeding the limits indicated in § 6.2.1.
- Check that the battery is correctly inserted.
- Make sure that the LCD display and the rotary switch indicate the same function.

1.2. DURING USE

Please carefully read the following recommendations and instructions:



CAUTION

Failure to comply with the caution notes and/or instructions may damage the instrument and/or its components or be a source of danger for the operator.

- Before activating the rotary switch, disconnect the test leads from the circuit being measured.
- When the instrument is connected to the circuit being measured, do not touch any unused terminal.
- During current measurement, any other current near the clamps may affect measurement precision.
- When measuring current, always put the conductor as near as possible to the middle of the clamp jaw, to obtain the most accurate reading.
- Do not measure resistance in case external voltages are present; even if the instrument is protected, an excessive voltage may cause malfunction
- Before attempting any resistance measurement, cut off power supply from the circuit to be measured and make sure that all capacitors are discharged, if present
- While measuring, if the value or the sign of the quantity being measured remain unchanged, check if the HOLD function is enabled.

1.3. AFTER USE

- When measurement is complete, set the rotary switch to OFF to switch off the instrument.
- If the instrument is not to be used for a long time, remove the batteries.

1.4. DEFINITION OF MEASUREMENT (OVERVOLTAGE) CATEGORY

Standard "IEC/EN61010-1: Safety requirements for electrical equipment for measurement, control and laboratory use, Part 1: General requirements", defines what measurement category, commonly called overvoltage category, is. § 6.7.4: Measured circuits, reads: Circuits are divided into the following measurement categories:

- **Measurement category IV** is for measurements performed at the source of the low-voltage installation.
Examples are electricity meters and measurements on primary overcurrent protection devices and ripple control units.
- **Measurement category III** is for measurements performed on installations inside buildings.
Examples are measurements on distribution boards, circuit breakers, wiring, including cables, bus-bars, junction boxes, switches, socket-outlets in the fixed installation, and equipment for industrial use and some other equipment, for example, stationary motors with permanent connection to fixed installation.
- **Measurement category II** is for measurements performed on circuits directly connected to the low-voltage installation.
Examples are measurements on household appliances, portable tools and similar equipment.
- **Measurement category I** is for measurements performed on circuits not directly connected to MAINS.
Examples are measurements on circuits not derived from MAINS, and specially protected (internal) MAINS-derived circuits. In the latter case, transient stresses are variable; for that reason, the standard requires that the transient withstand capability of the equipment is made known to the user.

2. GENERAL DESCRIPTION

The instrument carries out the following measurements:

- DC / AC, AC+DC TRMS voltage
- DC / AC / AC+DC TRMS voltage with low impedance (LoZ)
- DC / AC / AC+DC TRMS current with standard clamp transducers
- AC TRMS current with flexible transducer clamps
- Automatic recognition of AC and DC quantities
- Inrush current (Dynamic INRUSH - DIRC)
- Current/voltage harmonics up to the 25th and THD% calculation
- Resistance and Continuity test
- Current and voltage frequency
- Overall earth resistance without RCD tripping
- Loop impedance L-L, L-N and calculation of assumed short-circuit current
- Test on A and AC general RCDs
- Phase sequence with 1 terminal

Each of these functions can be selected by means of the appropriate switch. The instrument is also equipped with function keys (see § 4.2), an analogue bargraph and backlight. The instrument is also equipped with an Auto Power OFF function (which can be disabled), which automatically switches off the instrument 15 minutes after the last time a function key was pressed or the rotary switch was turned. To switch on the instrument again, turn the rotary switch.

2.1. MEASURING AVERAGE VALUES AND TRMS VALUES

Measuring instruments of alternating quantities are divided into two big families:

- AVERAGE-VALUE meters: instruments measuring the value of the sole wave at fundamental frequency (50 or 60 Hz).
- TRMS (True Root Mean Square) VALUE meters: instruments measuring the TRMS value of the quantity being tested.

With a perfectly sinusoidal wave, the two families of instruments provide identical results. With distorted waves, instead, the readings shall differ. Average-value meters provide the RMS value of the sole fundamental wave; TRSM meters, instead, provide the RMS value of the whole wave, including harmonics (within the instruments bandwidth). Therefore, by measuring the same quantity with instruments from both families, the values obtained are identical only if the wave is perfectly sinusoidal. In case it is distorted, TRMS meters shall provide higher values than the values read by average-value meters.

2.2. DEFINITION OF TRUE ROOT MEAN SQUARE VALUE AND CREST FACTOR

The root mean square value of current is defined as follows: *"In a time equal to a period, an alternating current with a root mean square value of 1A intensity, circulating on a resistor, dissipates the same energy that, during the same time, would be dissipated by a direct current with an intensity of 1A"*. This definition results in the numeric expression:

$$G = \sqrt{\frac{1}{T} \int_{t_0}^{t_0+T} g^2(t) dt}$$

The root mean square value is indicated with the acronym RMS.

The Crest Factor is defined as the relationship between the Peak Value of a signal and its

RMS value: $CF (G) = \frac{G_p}{G_{RMS}}$ This value changes with the signal waveform, for a purely

sinusoidal wave it is $\sqrt{2} = 1.41$. In case of distortion, the Crest Factor takes higher values as wave distortion increases.

3. PREPARATION FOR USE

3.1. INITIAL CHECKS

Before shipping, the instrument has been checked from an electric as well as mechanical point of view. All possible precautions have been taken so that the instrument is delivered undamaged.

However, we recommend generally checking the instrument in order to detect possible damage suffered during transport. In case anomalies are found, immediately contact the forwarding agent.

We also recommend checking that the packaging contains all components indicated in § 6.3.1. In case of discrepancy, please contact the Dealer.

In case the instrument should be returned, please follow the instructions given in § 7.

3.2. INSTRUMENT POWER SUPPLY

The instrument is supplied with 4x1.5V alkaline batteries type AAA IEC LR03, included in the package. When batteries are flat, the symbol  is shown on the display. To replace the batteries, see § 6.1.

3.3. STORAGE

In order to guarantee precise measurement, after a long storage time, wait for the instrument to come back to normal condition (see § 6.2.1).

4. NOMENCLATURE

4.1. DESCRIPTION OF THE INSTRUMENT

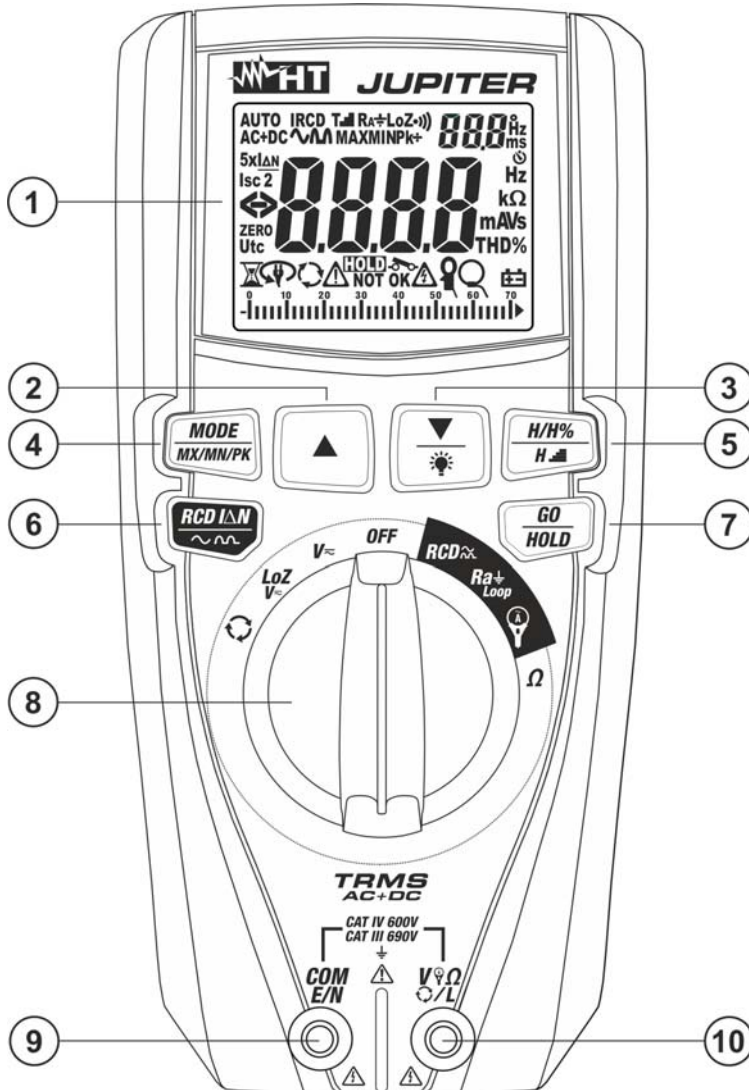

CAPTION:

1. LCD display
2. arrow key ▲
3. Key ▼/💡
4. Key **MODE/MX/MN/PK**
5. Key **H/H%/H**
6. Key **RCD I Δ N**
7. Key **GO/HOLD**
8. Rotary selector switch
9. Input terminal **COM**
10. Input terminal **V Ω L**

Fig. 1: Description of the instrument

4.1.1. Instrument's initial screen

1. Turn the rotary switch to any position to switch on the instrument. The following initial screen is shown on the display for a few seconds to identify the internal Firmware and Hardware version.



Fig. 2: Instrument's initial screen

2. Turn the rotary switch to **OFF** to switch off the instrument.

4.2. DESCRIPTION OF FUNCTION KEYS

4.2.1. Key GO/HOLD

Pressing the key **GO/HOLD** (for functions V_{\sim} , $LoZV_{\sim}$, Ω and I) makes the instrument hold the value of the quantity shown on the display. The message "HOLD" appears on the display. Press the key again to exit the function. Pressing the key **GO/HOLD** (for functions RCD_{\sim} , Ra_{\sim} , Loop , IRC) activates the corresponding measurement.

4.2.2. Key H/H%/H \blacksquare

Key **H/H%/H \blacksquare** (active in positions V_{\sim} , $LoZV_{\sim}$ and I) allows the following operations:

- Simple pressing of the key to display the amplitude of voltage and current harmonics up to the 25th (**Hdc**, **H01... H25**) in absolute or percentage format in relationship with the fundamentals of input signals (for voltage values $V_{AC} > 0.5V$ and current values $AC > 0.5A$ and frequency in the range $42.5Hz \div 69Hz$) and the percentage value of parameter **THD%** (see § 9.4) as shown in Fig. 3. Use keys \blacktriangle and $\blacktriangledown/\text{I}$ to increase/decrease the order of the harmonic.

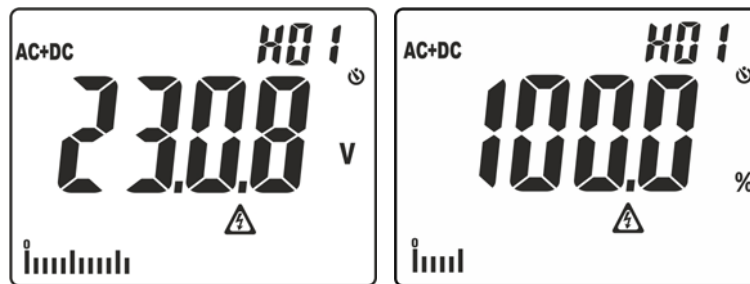

Fig. 3: Display of amplitude of harmonic analysis

- Long pressing of the key (at least 2s) in order to activate the **H₂O** (**H**igher **H**armonic **O**rdering) ordering function of the amplitude of harmonics. In these conditions, function "HOLD" is automatically activated, symbol \blacksquare is shown on the display, the bargraph is disabled and the instrument shows the value of amplitude of all harmonics between the 2nd and the 25th, in **decreasing order** from the harmonic with the highest value, as shown in Fig. 4.

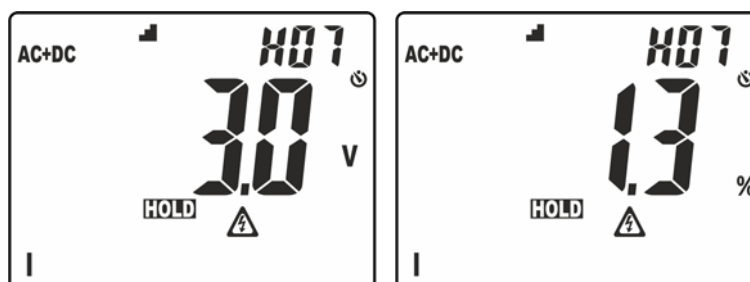









Fig. 4: Display of ordering of amplitude of harmonic analysis

In the example in Fig. 4, the harmonic with the highest value corresponds to the 7th. Press key \blacktriangle to observe the amplitude of the remaining harmonics and press key **H/H%/H \blacksquare** again to switch between display in absolute and percentage values. Turn the rotary switch to exit the function.

4.2.3. Key MODE/MXMNPK





A simple pressing of key **MODE/MXMNPK** allows for the following operations:



- Selection of measuring modes “AUTO”, “AC”, “DC”, “AC+DC” and “FREQ” in positions **V_~**, **LoZV_~**
- Selection of measuring modes “AUTO”, “AC”, “DC”, “AC+DC”, “FREQ” and “IRC” (see § 4.2.8) in position 
- Selection of clamp transducer type in current measurement between options  (optional standard clamps) and “” (optional flexible clamp) in position 
- Selection of measurement of Overall earth resistance without RCD tripping RCD (**RCDRa_⊥**), Overall earth resistance L-PE (100mA) and Loop impedance L-L, L-N in position **Ra_⊥Loop**
- Selection of measurement of tripping time at “ $\frac{1}{2}I_{\Delta n}$ ”, “ $I_{\Delta n}$ ”, “ $5xI_{\Delta n}$ ” and tripping current “” of the RCD switch in position **RCD_~**
- Selection of measurement of Resistance “ Ω ” or Continuity test “” in position Ω

A long pressing (>2s) of key **MODE/MXMNPK** allows for the activation/deactivation of continuous detection of maximum value (MAX), minimum value (MIN), positive peak (Pk+), negative peak (Pk-) of the quantity (voltage or current) to be measured. The values are constantly updated and are displayed cyclically every time the same key is pressed. This function is not active in position . Press and hold key **MODE/MXMNPK** (>2s) or use the selector to exit the function.

4.2.4. Keys / and

A simple pressing of keys / and  allows for the following operations:

- Setting of the full scale value of flexible clamp transducer (optional accessory - option “”) in position  among values: **30A, 300A, 3000A** for AC current measurement.
- Setting of the full scale value of standard clamp transducer (option “”) in position  among values: **1A, 10A, 30A, 40A, 100A, 200A, 300A, 400A, 1000A, 2000A, 3000A** for AC and DC current measurement.
- Selection of harmonic order “DC ÷ 25°” in positions **V_~**, **LoZV_~** and 
- Selection of calculation time of RMS value in DIRC function (see § 4.2.8).
- Selection of limit on assumed contact voltage in positions **Ra_⊥Loop** and **RCD_~** among the options: **25V, 50V** (see § 4.2.10)
- Zeroing of cable resistance in position Ω (see § 5.4)



Long pressing (>2s) of key / allows activating/deactivating display backlight. This function is activated in any position of the rotary switch and is automatically deactivated after approx. 2 minutes' idling.

4.2.5. Key RCDI Δ N/

A simple pressing of key **RCDI Δ N/** allows for the following operations:

- selection of rated tripping current of the RCD among the options: **30mA, 100mA, 300mA** in position **RCD_~**

A long pressing (>2s) of key **RCDI Δ N/** allows for the following operations:

- Selection of the type of RCD among the options: “” (type AC), “” (type A) in position **RCD_~**

4.2.6. LoZ function

This mode allows carrying out AC/DC voltage measurement with a low input impedance, in order to eliminate wrong readings due to parasite voltages for capacitive couplings.



CAUTION

By plugging the instrument between the phase and earth conductor, because of the low impedance of the instrument during measurement, RCD protections may trip while carrying out the test. If this test is to be carried out, first carry out a measurement of at least 5s between phase and neutral in the presence of voltage.

4.2.7. AC+DC function

The instrument is capable of measuring a possible presence of overlapping alternating components on a generic direct waveform (voltage or current). This can be useful when measuring typical impulsive signals of non-linear loads (e.g. welding machines, ovens).

4.2.8. Inrush current function (INRUSH)

Measurement of inrush current (see § 5.9) is intended as the recognition of an event detected upon exceeding of a trigger threshold. If the instant value exceeds this threshold (**fixed, equal to 1%FS clamp**), the instrument shows on the display the maximum Peak value (calculated in **1ms**) and the maximum RMS value calculated with a time which can be selected among options: **16.7ms, 20ms, 50ms, 100ms (default), 150ms, 175ms and 200ms**.

4.2.9. Disabling the Auto Power Off function

In order to preserve internal batteries, the instrument switches off automatically approximately 15 minutes after it was last used. Press key **MODE/MXMNPK** or move selector from **OFF** position to switch on the instrument. To disable the Auto Power Off function, proceed as follows:

- Switch off the instrument (**OFF**)
- Press and hold key **▲** to switch on the instrument. The symbol “” disappears from the display
- Switch off and then on again the instrument or press key **MODE/MXMNPK** to enable the function again.

4.2.10. Setting the contact voltage limit

In order to set the limit on contact voltage U_t , used in positions **Ra \neq Loop** and **RCD \approx** , proceed as follows:

1. Switch off the instrument (**OFF**)
2. Press and hold key **▼/⚡** switch on the instrument by turning the rotary switch. The screen in Fig. 5 – left side appears on the display with a flashing “Set” symbol.

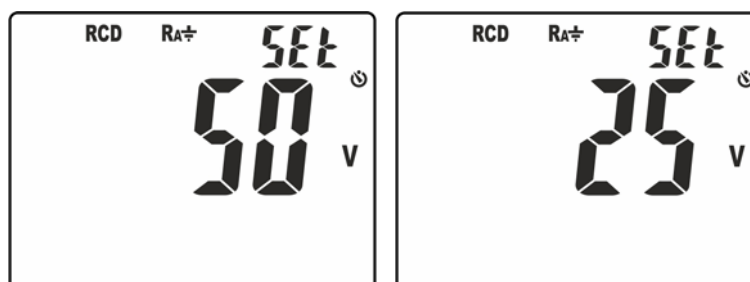

Fig. 5: Setting the contact voltage limit

3. Press keys **▼/⚡** or **▲** to select limit values **50V** or **25V**.
4. Press key **GO/HOLD** to confirm and go back to measuring screen.

4.2.11. Setting the rated voltage in Loop/Ra measurement

To set the value of rated voltage necessary to instrument in order to calculate the assumed short-circuit current in position **Ra \neq Loop**, proceed as follows:

1. Select the position **Ra \neq Loop**
2. Long press (>2s) the **MODE/MXMNPK** key. The followed screen appears on the display with a flashing "Set" symbol.



Fig. 6: Setting the rated voltage in Loop measurement

3. Press keys ∇ / lightbulb or \blacktriangle to set the value of rated voltage (Phase-Earth, Phase-Neutral or Phase-Phase) in range **100V \div 690V**. Press and hold keys ∇ / lightbulb or \blacktriangle for a quick setting of the desired value.
4. Press key **GO/HOLD** to confirm and go back to measuring screen.

4.2.12. Setting full scale of flexible clamp

The instrument can be used with flexible transducer clamp (optional accessory). For a correct current measurement is **necessary** set the voltage full scale of the used clamp (consider the user manual of the transducer in order to know the correct full scale). Proceed as follows

1. Switch off the instrument (**OFF**)
2. Press and hold key **MODE/MXMNPK** switch on the instrument by turning the rotary switch. The followed screen appears on the display:



Fig. 7: Setting full scale of flexible clamp

3. Press keys ∇ / lightbulb or \blacktriangle to set the full scale of used clamp between the options: **3VAC** (F3000U model) or **1VAC** (other models)
4. Press key **GO/HOLD** to confirm and go back to measuring screen
5. The performed settings are saved at each re-boot

5. OPERATING INSTRUCTIONS

5.1. DC VOLTAGE MEASUREMENT

CAUTION



The maximum input DC voltage is 690V. Do not measure voltages exceeding the limits given in this manual. Exceeding voltage limits could result in electrical shocks to the user and damage to the instrument.

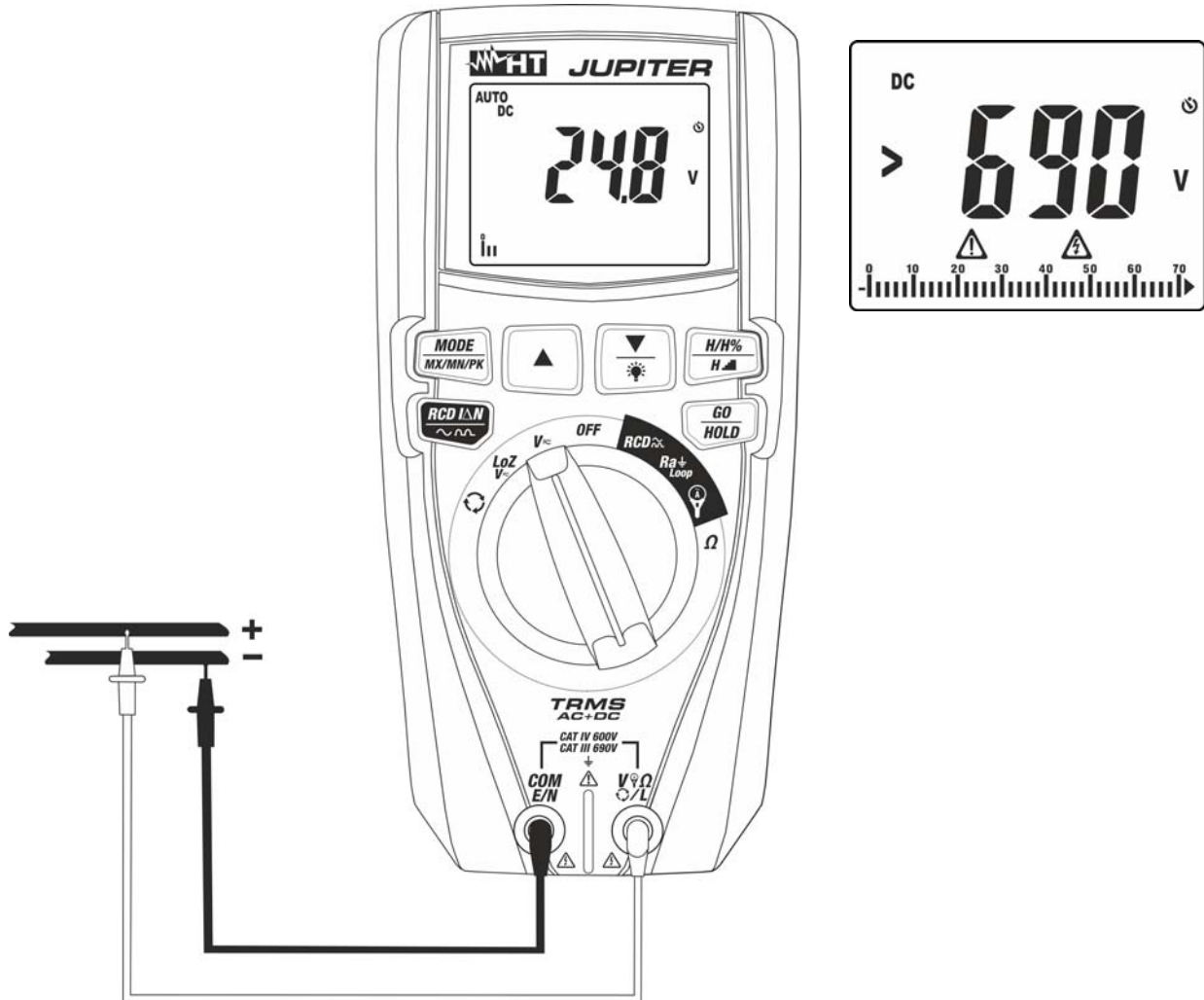

Fig. 8: Use of the instrument for DC voltage measurement

1. Select position V_{\sim}
2. Insert the red cable into input terminal $V\Omega\Omega L$ and the black cable into input terminal **COM/E/N**.
3. Position the red lead and the black lead respectively in the spots with positive and negative potential of the circuit to be measured (see Fig. 8). The display shows the value of voltage.
4. If the display shows the message "**>690V**" (see Fig. 8), the maximum measurable value has been reached.
5. When symbol "-" appears on the instrument's display, it means that voltage has the opposite direction with respect to the connection in Fig. 8.
6. To use HOLD, MAX/MIN/PK functions see § 4.2.

5.2. AC, AC+DC VOLTAGE MEASUREMENT
CAUTION

The maximum input AC voltage is 690V to earth. Do not measure voltages exceeding the limits given in this manual. Exceeding voltage limits could result in electrical shocks to the user and damage to the instrument.

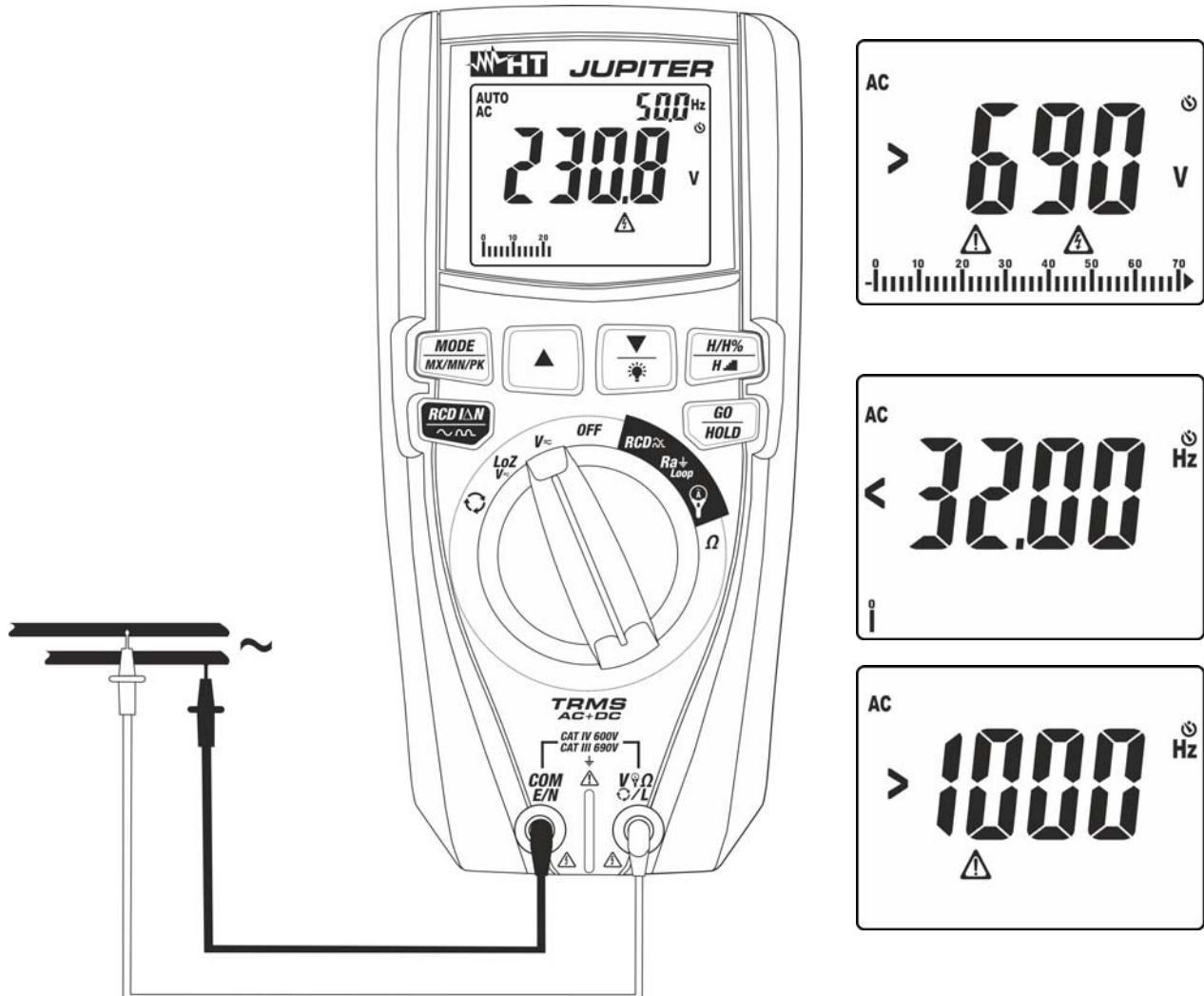

Fig. 9: Use of the instrument for AC voltage measurement

1. Select position V_{\sim}
2. Press the **MODE/MX/MN/PK** key until symbol "AC" or "AC+DC" is displayed. The instrument automatically recognizes AC or DC signals.
3. Insert the red cable into input terminal V_{Ω} and the black cable into input terminal **COM/E/N**.
4. Position the red lead and the black lead respectively in the spots of the circuit to be measured (see Fig. 9). The display shows the value of voltage. On the top of the display on the right side, the value of voltage frequency is displayed. Press key **MODE/MX/MN/PK** to display the value of frequency with a higher resolution.
5. If the display shows the message ">690V" (see Fig. 9), the maximum measurable value has been reached.
6. If the display shows the messages "<32Hz" or ">1000Hz" (see Fig. 9), the value of frequency is out of the measuring range 32Hz ÷ 1000Hz.
7. To use HOLD, MAX/MIN/PK, H/H%/H▬ functions, see § 4.2

5.3. AC, DC, AC+DC VOLTAGE WITH LOW IMPEDANCE (LOZ)
CAUTION

The maximum input AC/DC voltage is 690V to earth. Do not measure voltages exceeding the limits given in this manual. Exceeding voltage limits could result in electrical shocks to the user and damage to the instrument.

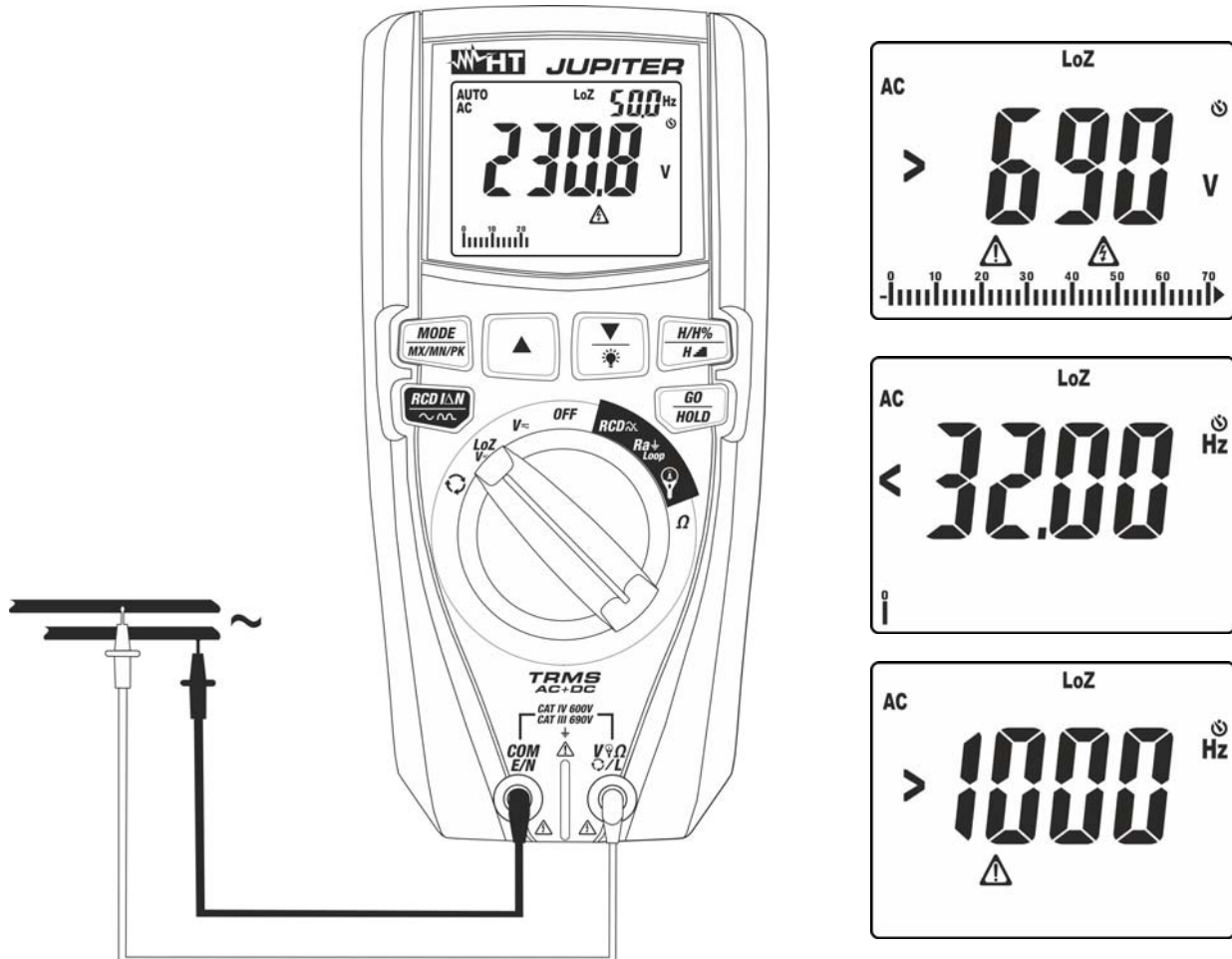

Fig. 10: Use of the instrument for AC/DC voltage measurement with LoZ function

1. Select position **LoZV**. The symbols “LoZ” and “DC” appear on the display.
2. Press key **MODE/MX/MN/PK** to select “AC” or “AC+DC” measurement. Anyway, the instrument automatically recognizes AC or DC signals.
3. Insert the red cable into input terminal **V Ω OL** and the black cable into input terminal **COM/E/N**.
4. Position the red lead and the black lead respectively in the positions of the circuit to be tested (see Fig. 10) for AC voltage measurement or in the positions with a positive or negative potential of the circuit to be tested (see Fig. 8) for DC voltage measurement. The display shows the value of voltage. On the top of the display on the right side, the value of voltage frequency is displayed. Press key **MODE/MX/MN/PK** to display the value of frequency with a higher resolution.
5. If the display shows the messages “<32Hz” or “>1000Hz” (see Fig. 10), the value of frequency is out of the measuring range **32Hz ÷ 1000Hz**.
6. When symbol “-” appears on the instrument’s display, it means that voltage has the opposite direction with respect to the connection in Fig. 8.
7. To use HOLD, MAX/MIN/PK, H/H%/H functions, see § 4.2

5.4. RESISTANCE MEASUREMENT AND CONTINUITY TEST
CAUTION

Before attempting any resistance measurement, cut off power supply from the circuit to be measured and make sure that all capacitors are discharged, if present.

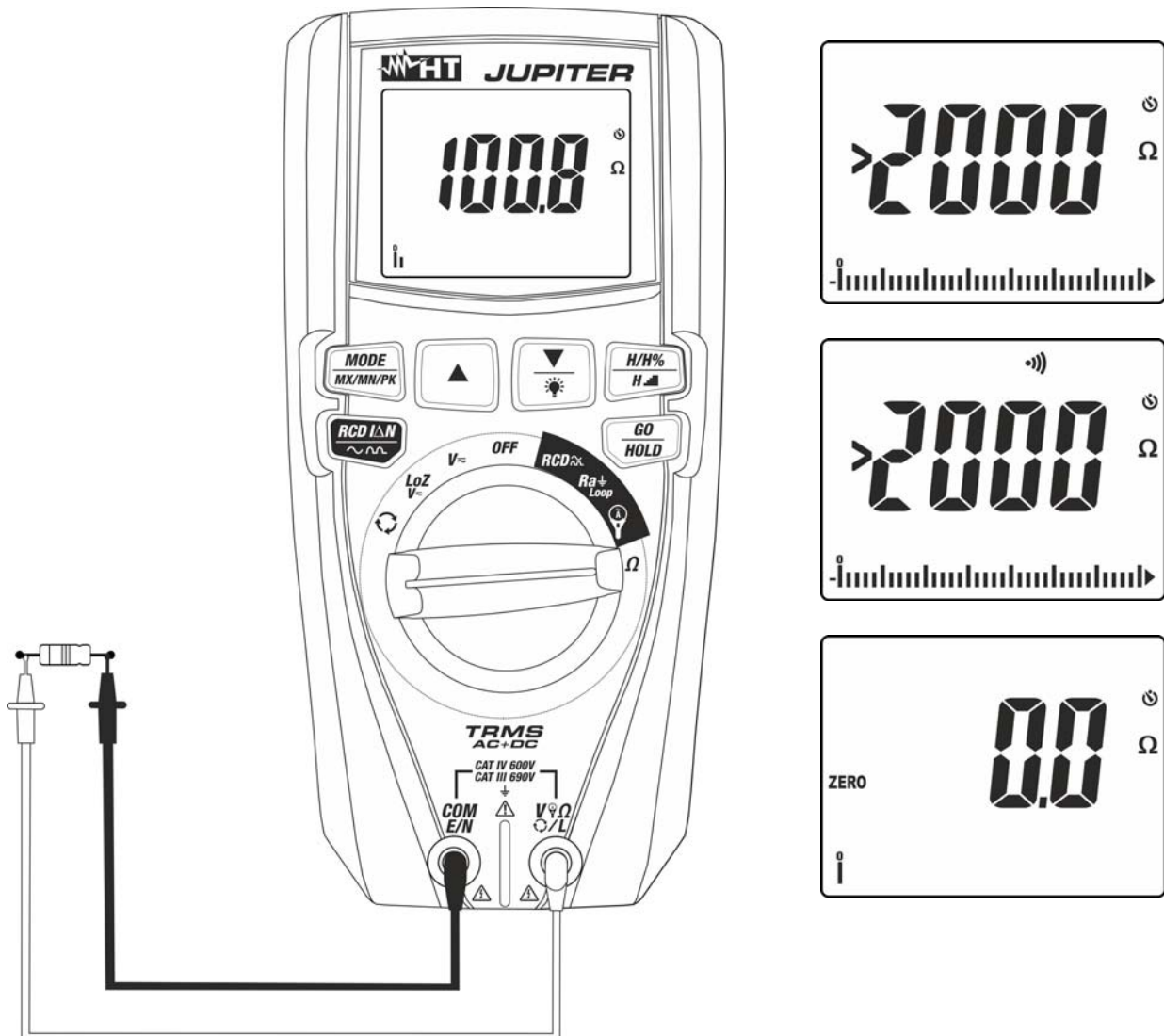

Fig. 11: Use of the instrument for resistance measurement and continuity test

1. Select the position. Ω
2. Insert the red cable into input terminal $V\Omega\Omega L$ and the black cable into input terminal **COM/E/N**.
3. If necessary, short-circuit the measuring leads and press key \blacktriangle to zero the resistance of the measuring cables. The symbol "ZERO" appears on the display.
4. Position the test leads in the desired spots of the circuit to be measured (see Fig. 11). The display shows the value of resistance.
5. If the display shows the message ">2000 Ω " (see Fig. 11) the maximum measurable value has been reached.
6. Press key **MODE/MX/MN/PK** to select ")))" measurement, relevant to the continuity test, and position the test leads in the desired positions of the circuit to be measured.
7. The value of resistance (which is only indicative) is displayed in Ω and the instrument sounds if the value of resistance is $<30.\Omega$
8. To use HOLD, MAX/MIN, H/H%/H▬ functions, see § 4.2

5.5. PHASE SEQUENCE AND PHASE CONCORDANCE WITH 1 TERMINAL
CAUTION

- Input AC voltage to carry out this test must be in range **130V ÷ 690V** with a frequency in range **42.5Hz ÷ 69Hz**.
- This test can only be performed by **touching the metal parts of the conductors**.

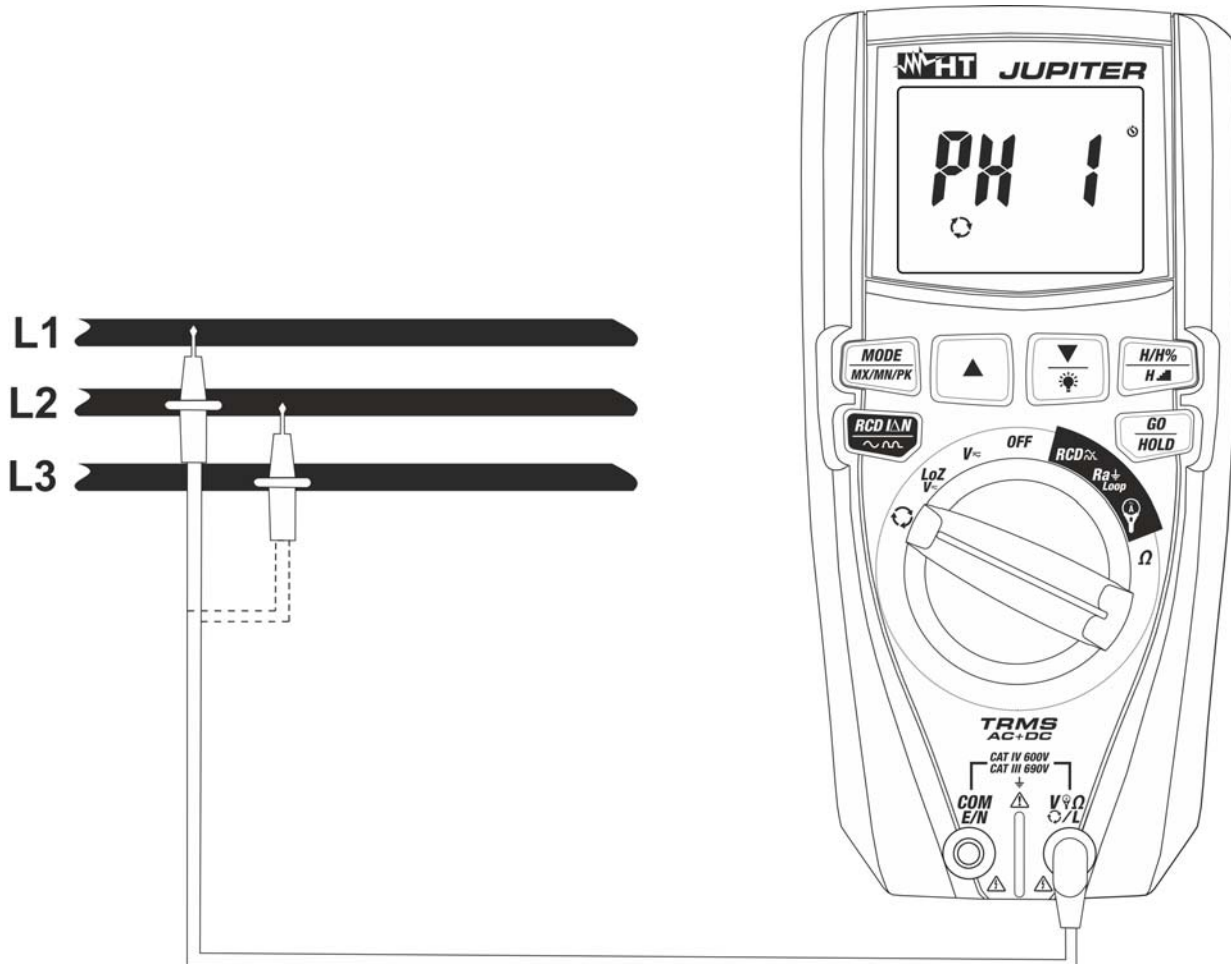

Fig. 12: Use of the instrument for phase sequence and phase concordance test

1. Select position . Message "**PH 1**" flashes on the display.
2. Insert the red lead into input terminal **VΩL**.
3. Position the red lead onto phase **L1** of the three-phase system to be tested (see Fig. 12). The following messages may appear on the display (see Fig. 13) to identify the presence of a voltage signal with frequency out of range **42.5Hz ÷ 69Hz**. In these conditions, the instrument does not perform the test.

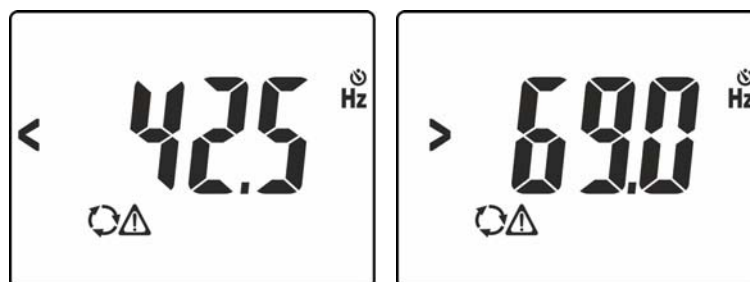

Fig. 13: Signal of voltage with wrong frequency

4. In conditions of correct voltage and frequency, the instrument shows message “**HOLD**”, symbols and “PH1” and the buzzer sounds continuously, waiting for a stable voltage value on phase L1 to be detected (see Fig. 14 – left side).

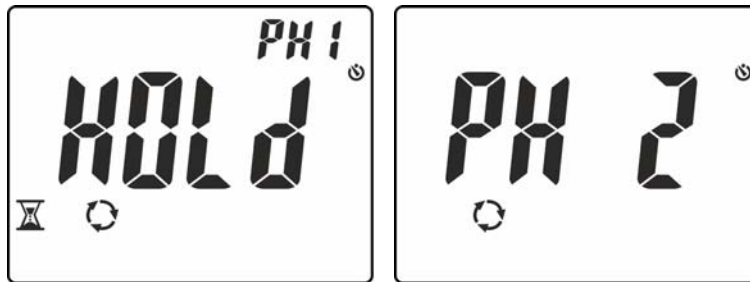

Fig. 14: Detecting phase L1 and waiting for phase L2

5. **Do not remove the lead from phase L1** until message “**PH 2**” appears flashing on the display (see Fig. 14 – right side)

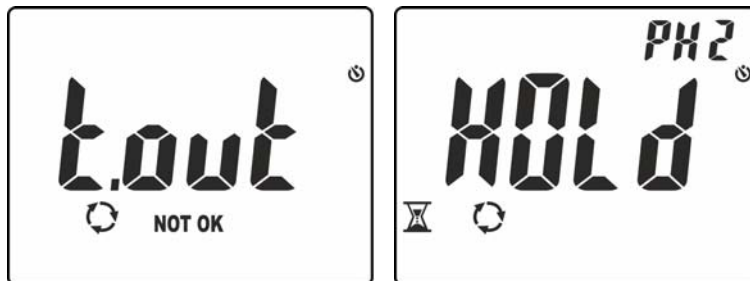

Fig. 15: Detecting phase L1 and waiting for phase L2

6. Position the red lead onto phase **L2** of the three-phase system to be tested (see Fig. 12). In case passage between phase L1 and phase L2 takes more than **10s**, the instrument shows message “**t.out**” on the display (see Fig. 15 – left side). In conditions of correct voltage and frequency, the instrument shows message “**HOLD**”, symbols and “PH2” and the buzzer sounds continuously, waiting for a stable voltage value on phase L2 to be detected (see Fig. 15 – right side)
7. Upon detection of a stable voltage value on phase L2, the instrument automatically shows message “**1.2.3.**” (test OK) or message “**2.1.3.**” (test NOT OK) as shown in Fig. 16.



Fig. 16: Results of phase sequence and phase concordance test

8. In case it is necessary to check phase concordance between two parallel three-phase systems, after detection of phase L1 of the first system, position the lead on phase L1 of the second system. The correct final result is message “**1.1-**” (see Fig. 16 – right side)

5.6. OVERALL EARTH RESISTANCE WITHOUT RCD TRIPPING

This function is performed in compliance with standards CEI 64-8 612.6.3, IEC/EN61557-6 and allows measuring the impedance of the fault loop, comparable to the overall earth resistance in TT systems (see § 9.2).

CAUTION



- The maximum input AC voltage is 690V to earth and between inputs. Do not measure voltages exceeding the limits given in this manual. Exceeding voltage limits could result in electrical shocks to the user and damage to the instrument.
- The measurement of overall earth resistance involves the circulation of a current of approx. **15mA** between phase and earth according to the technical specifications of the instrument (see § 7.1). This could cause the tripping of possible protections with lower tripping currents.

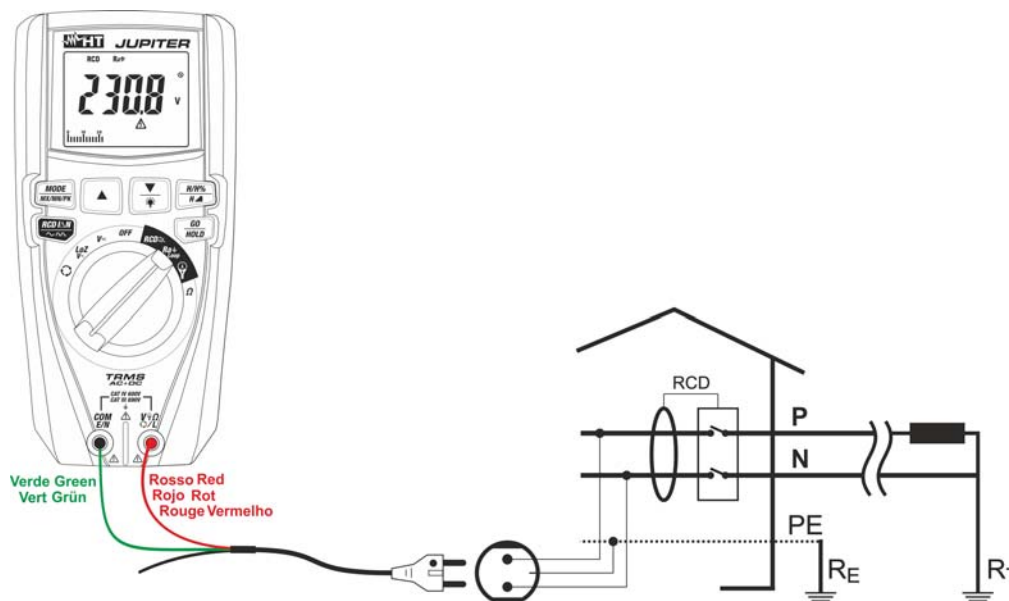

Fig. 17: Use of the instrument for measuring overall earth resistance with Schuko cable.

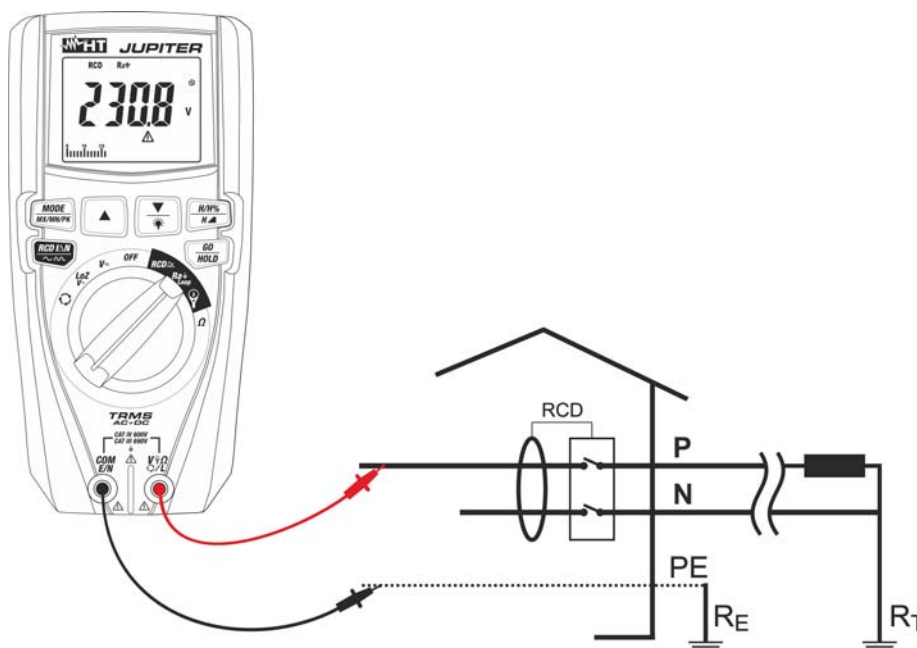
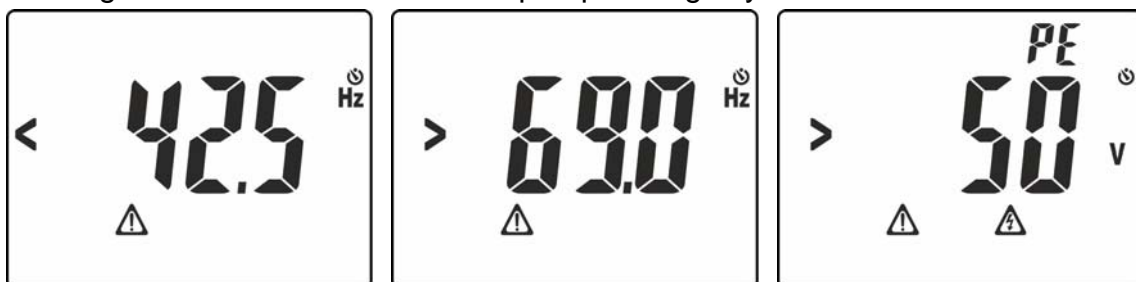
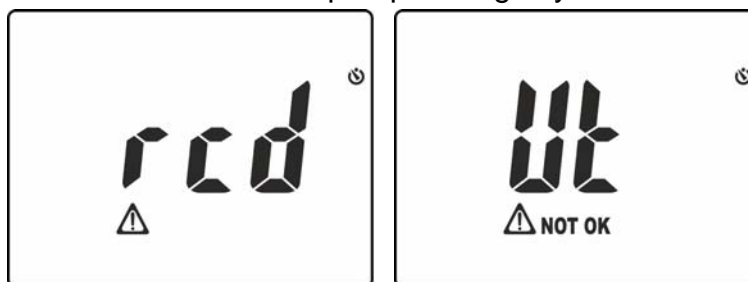



Fig. 18: Use of the instrument for measuring overall earth resistance with leads

1. set the value of rated voltage Phase-Earth (see § 4.2.11)
2. Set the limit value of contact voltage (see § 4.2.10)
3. Select position **Ra \downarrow Loop**.
4. Press key **MODE/MXMNPK** and select option “RCD Ra \downarrow ”
5. In case the cable with Shuko plug is used, insert the red conductor into input terminal **V Ω L** and the green conductor into input terminal **COM/E/N** and connect the instrument to the system to be tested (see Fig. 17). The value of voltage Phase-Earth is shown on the display
6. In case measuring leads are used, insert the red conductor into input terminal **V Ω L** and the black conductor into input terminal **COM/E/N** and connect the instrument to the system to be tested (see Fig. 18). The value of voltage Phase-Earth is shown on the display
7. Press key **GO/HOLD** to activate the test. The following screens may appear on the display for a few seconds to signal anomalous conditions in which the instrument does not carry out the test:

 Fig. 19: Anomalous situations upon pressing key **GO/HOLD** – Screen 1

 Fig. 20: Anomalous situations upon pressing key **GO/HOLD** – Screen 2

 Fig. 21: Anomalous situations upon pressing key **GO/HOLD** – Screen 3

L-PE	Turn the Schuko plug in the socket to be tested
< 100V	Input voltage < 100V. Check the electric mains
> 690V	Input voltage > 690V. Check the electric mains
< 42.5Hz	Input voltage frequency < 42.5Hz. Check the electric mains
> 69.0Hz	Input voltage frequency > 69.0Hz. Check the electric mains
> 50V	Dangerous voltage on PE conductor > 50V. Check the earth circuit
RCD	RCD tripped check for possible current leaks to earth and disconnect the users from the line to be tested
Ut	Contact voltage above limit (25V/50V). Check the earth circuit and disconnect the users from the line to be tested

8. In case no anomalous conditions are present, the instrument carries out the test and symbol  flashes on the display. At the end of the test, the following screens appear on the display.

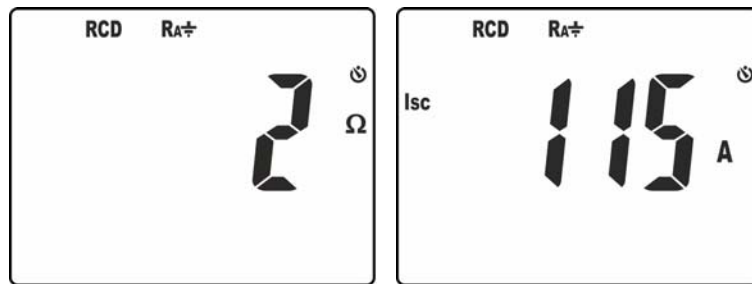





Fig. 22: Results of measurement of overall earth resistance

9. The screen in Fig. 22 – left side shows the value of overall earth resistance. Press keys / or  to display the value of assumed short-circuit current **Isc** (see § 9.3)

5.7. MEASUREMENT OF LINE/LOOP IMPEDANCE

This function is performed in compliance with standards CEI 64-8 612.6.3, IEC/EN61557-3 and allows measuring line impedance, fault loop impedance and the assumed short-circuit current (see § 9.3). The following operating modes are available:

- **L-N** the instrument measures line impedance between phase and neutral conductor and calculates the assumed phase-to-neutral short-circuit current.
- **L-L** the instrument measures line impedance between two phase conductors and calculates the assumed phase-to-phase short-circuit current.
- **L-PE** the instrument measures the fault loop impedance between phase and earth conductor $R_{a\frac{1}{2}}$ and calculates the assumed phase-to-earth short-circuit current).

CAUTION



- The maximum input AC voltage is 690V to earth and between inputs. Do not measure voltages exceeding the limits given in this manual. Exceeding voltage limits could result in electrical shocks to the user and damage to the instrument.
- The measurement of overall earth resistance involves the circulation of a current of approx. **100mA** between phase and earth according to the technical specifications of the instrument (see § 7.1). This could cause the tripping of possible protections with lower tripping currents.

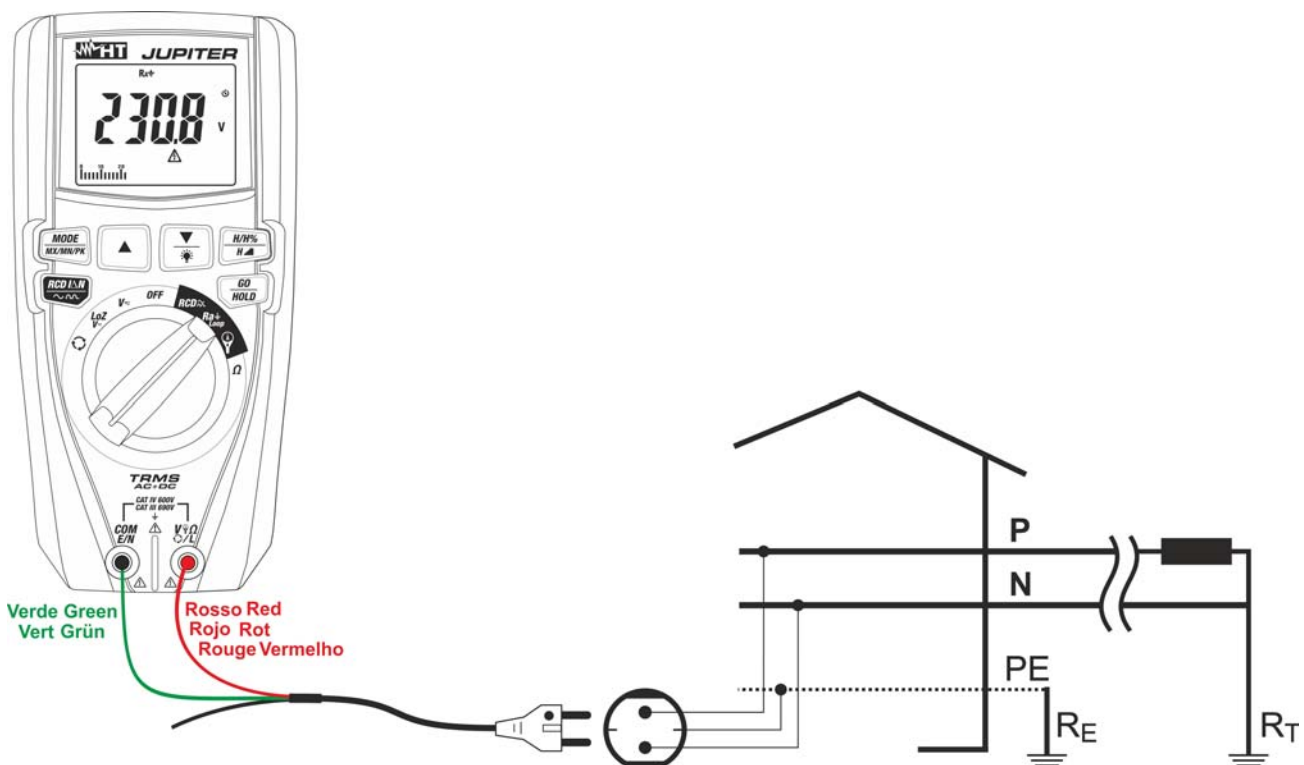

Fig. 23: Use of the instrument for measuring Loop L-PE impedance with cable provided with Schuko plug

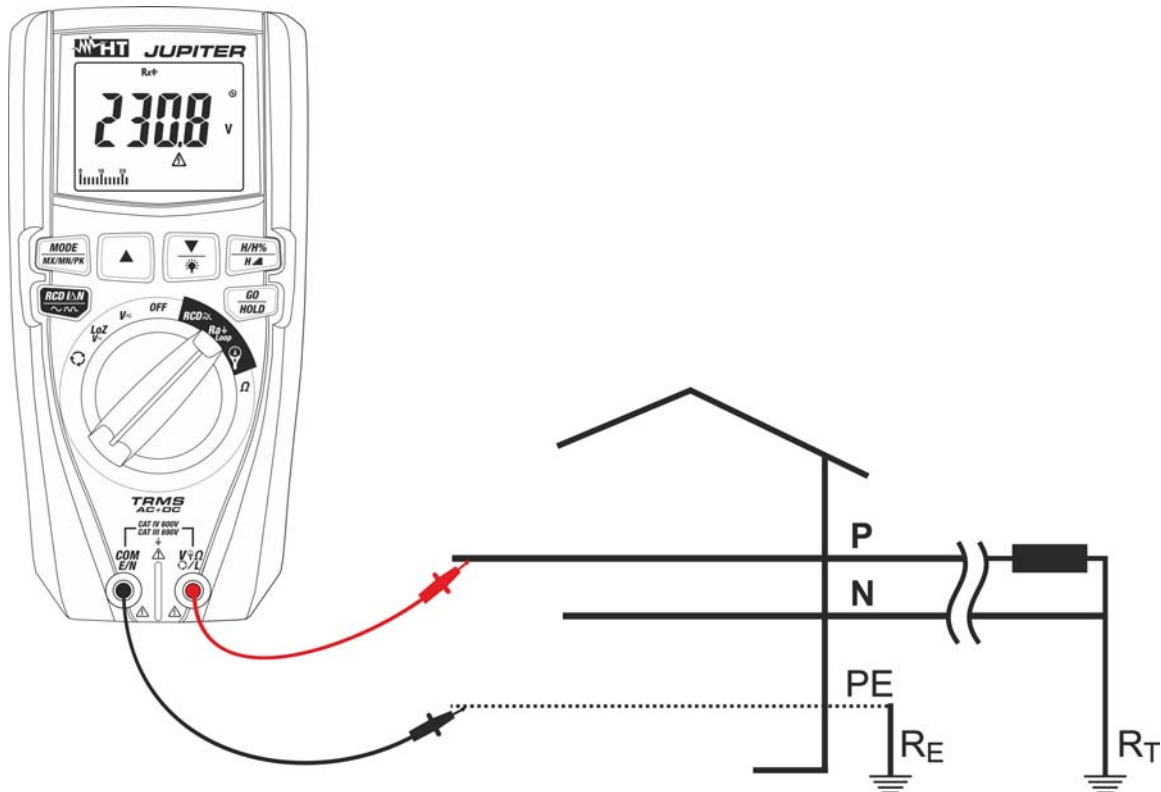

Fig. 24: Use of the instrument for measuring Loop L-PE impedance with leads

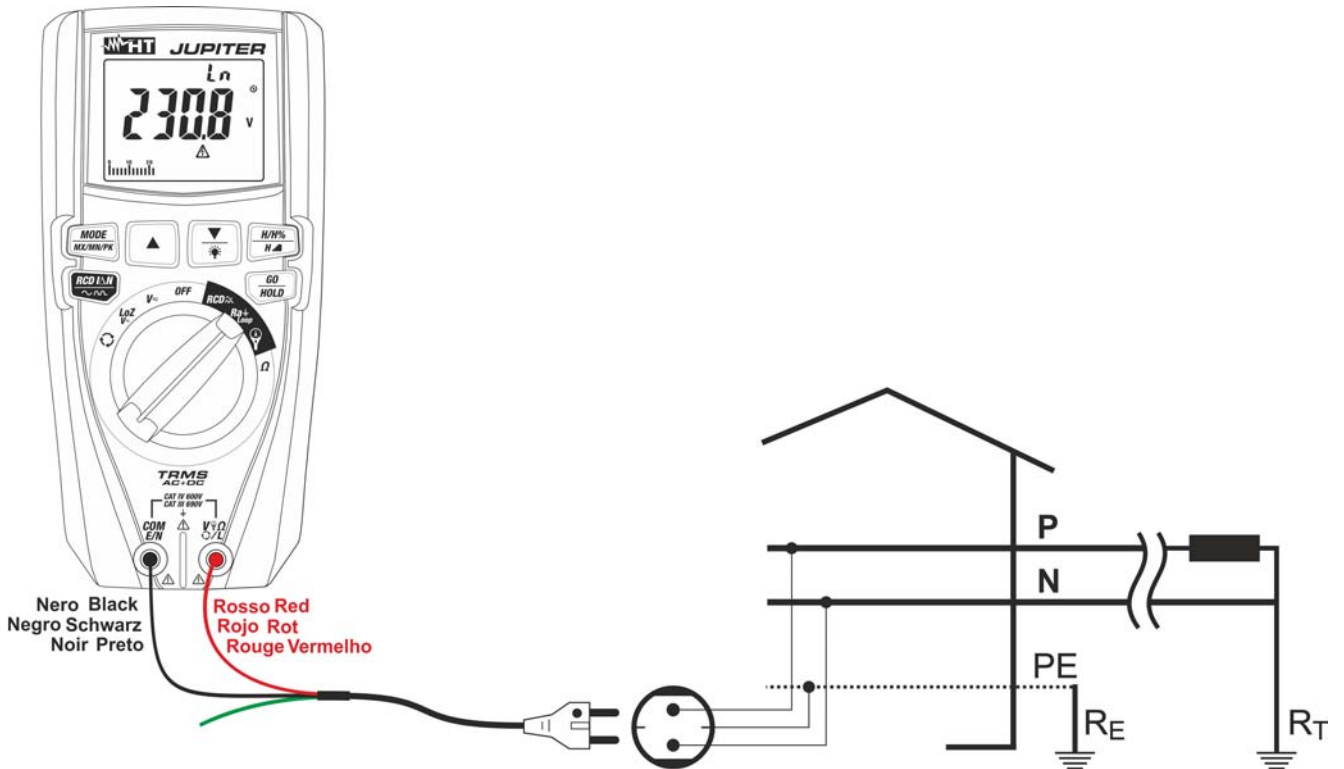

Fig. 25: Use of the instrument for measuring Loop L-N impedance with cable provided with Schuko plug

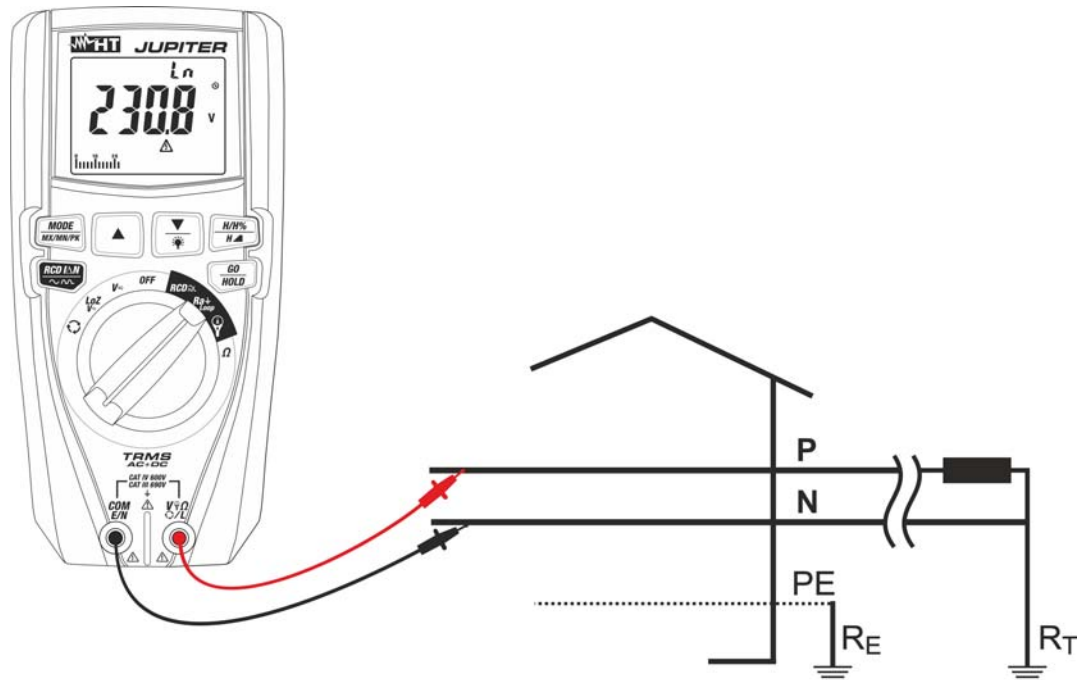

Fig. 26: Use of the instrument for measuring Loop L-N impedance with leads

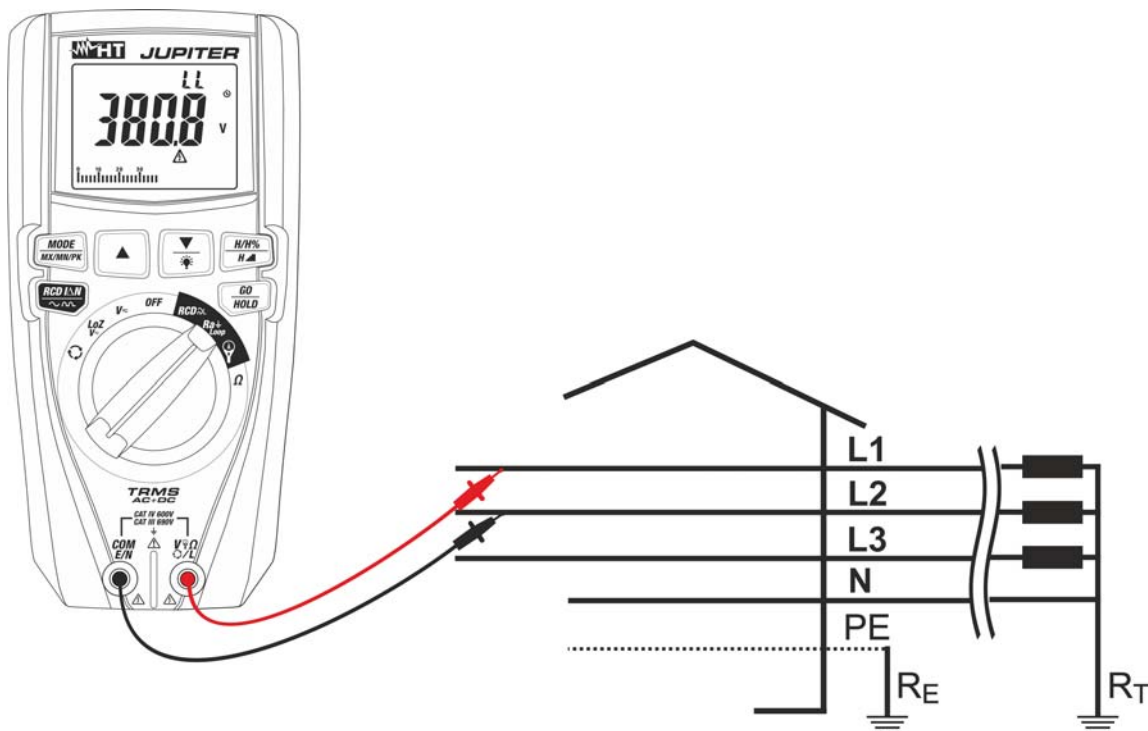

Fig. 27: Use of the instrument for measuring Loop L-L impedance with leads

1. Set the value of rated phase-to-earth, phase-to-neutral or phase-to-phase voltage (see § 4.2.11)
2. Set the limit value of contact voltage (see § 4.2.10)
3. Select position $Ra \frac{1}{\text{Loop}}$.
4. Press key **MODE/MXMNPK** and select one of the options “ $Ra \frac{1}{\text{Loop}}$ ”, “Ln” or “LL”
5. **For Loop L-PE measurements**, in case the cable with Shuko plug is used, insert the red conductor into input terminal $V \Omega \Omega L$ and the green conductor into input terminal **COM/E/N** and connect the instrument to the system to be tested (see Fig. 23). The value of voltage Phase-Earth is shown on the display

6. **For Loop L-PE measurements**, in case measuring leads are used, insert the red conductor into input terminal $V_{\Omega} \text{ L}$ and the black conductor into input terminal **COM/E/N** and connect the instrument to the system to be tested (see Fig. 24). The value of voltage Phase-Earth is shown on the display
7. **For Loop L-N measurements**, in case the cable with Shuko plug is used, insert the red conductor into input terminal $V_{\Omega} \text{ L}$ and the black conductor into input terminal **COM/E/N** and connect the instrument to the system to be tested (see Fig. 25). The value of phase-to-neutral voltage is shown on the display
8. **For Loop L-N measurements**, in case measuring leads are used, insert the red conductor into input terminal $V_{\Omega} \text{ L}$ and the black conductor into input terminal **COM/E/N** and connect the instrument to the system to be tested (see Fig. 26). The value of phase-to-neutral voltage is shown on the display
9. **For Loop L-L measurements**, in case measuring leads are used, insert the red conductor into input terminal $V_{\Omega} \text{ L}$ and the black conductor into input terminal **COM/E/N** and connect the instrument to the system to be tested (see Fig. 27). The value of phase-to-phase voltage is shown on the display
10. Press key **GO/HOLD** to activate the test. The screens shown in Fig. 19, Fig. 20 and Fig. 21 may appear on the display for a few seconds to signal anomalous conditions in which the instrument does not carry out the test.
11. In case no anomalous conditions are present, the instrument carries out the test and symbol H flashes on the display. at the end of the test, the following screens (e.g. relevant to Loop L-L measurement) are shown on the display

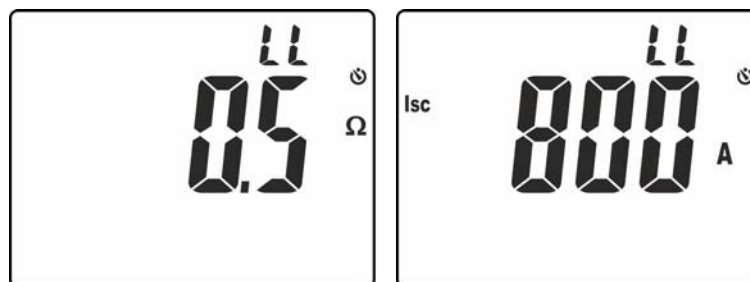



Fig. 28: Results of Loop L-L impedance measurement

12. The screen in Fig. 28 – left side, shows the value of Loop L-L impedance. Press keys $\blacktriangledown/\text{H}$ or \blacktriangle to display the value of the assumed short-circuit current **Isc** (see § 9.3)

5.8. TEST ON A AND AC RCDS

This function is performed in compliance with standard IEC/EN61557-6 and allows measuring the tripping time and the current of the **instant general** RCDs of the system (see § 9.1). The following operating modes are available:

- **AUTO** the instrument automatically carries out a sequence of six measurements with a leakage current equal to half, once or five times the set value of rated current and with a leakage current in phase with the positive and negative half-wave of the mains voltage. Recommended mode
- **x $\frac{1}{2}$** the instrument performs measurement with a leakage current equal to half the set value of rated current
- **x1** the instrument performs measurement with a leakage current equal to once the set value of rated current
- **x5** the instrument performs measurement with a leakage current equal to five times the set value of rated current
-  the instrument performs measurement with an increasing leakage current. This mode is recommended to determine the real tripping current of the RCD.

CAUTION



- The maximum input AC voltage is 690V to earth and between inputs. Do not measure voltages exceeding the limits given in this manual. Exceeding voltage limits could result in electrical shocks to the user and damage to the instrument.
- Testing the RCDs' tripping time causes the RCDs' tripping. **Therefore check that there are NO users or loads connected downstream of the RCD being tested which could be damaged by a system downtime.** Disconnect all loads connected downstream of the RCD as they could produce leakage currents further to those produced by the instrument, thus invalidating the results of the test.

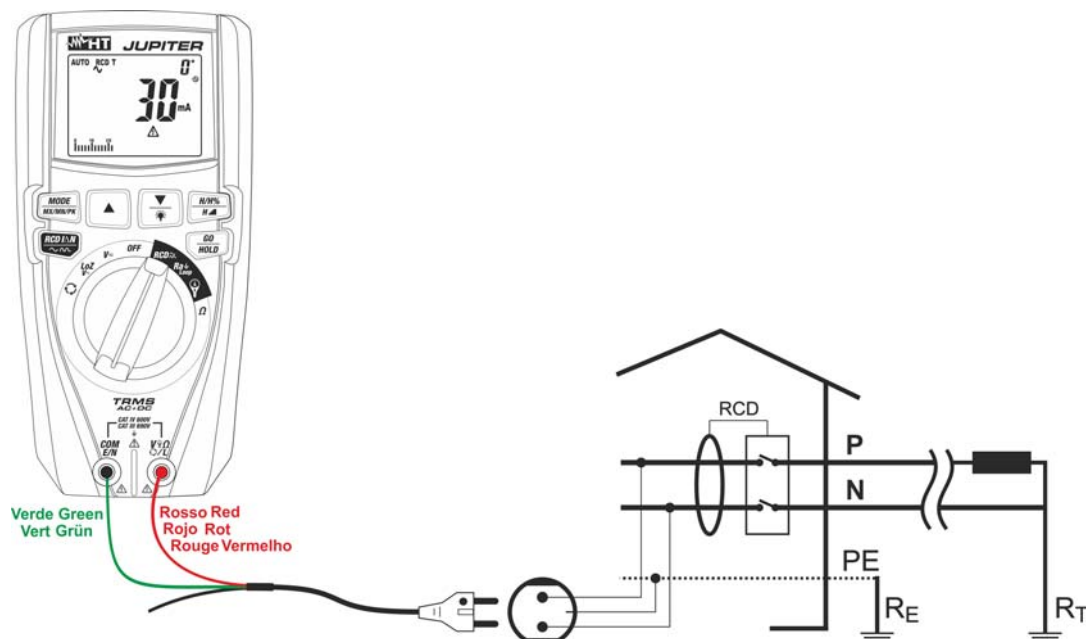

Fig. 29: Use of the instrument for RCD test on single-phase system with cable provided with Schuko plug

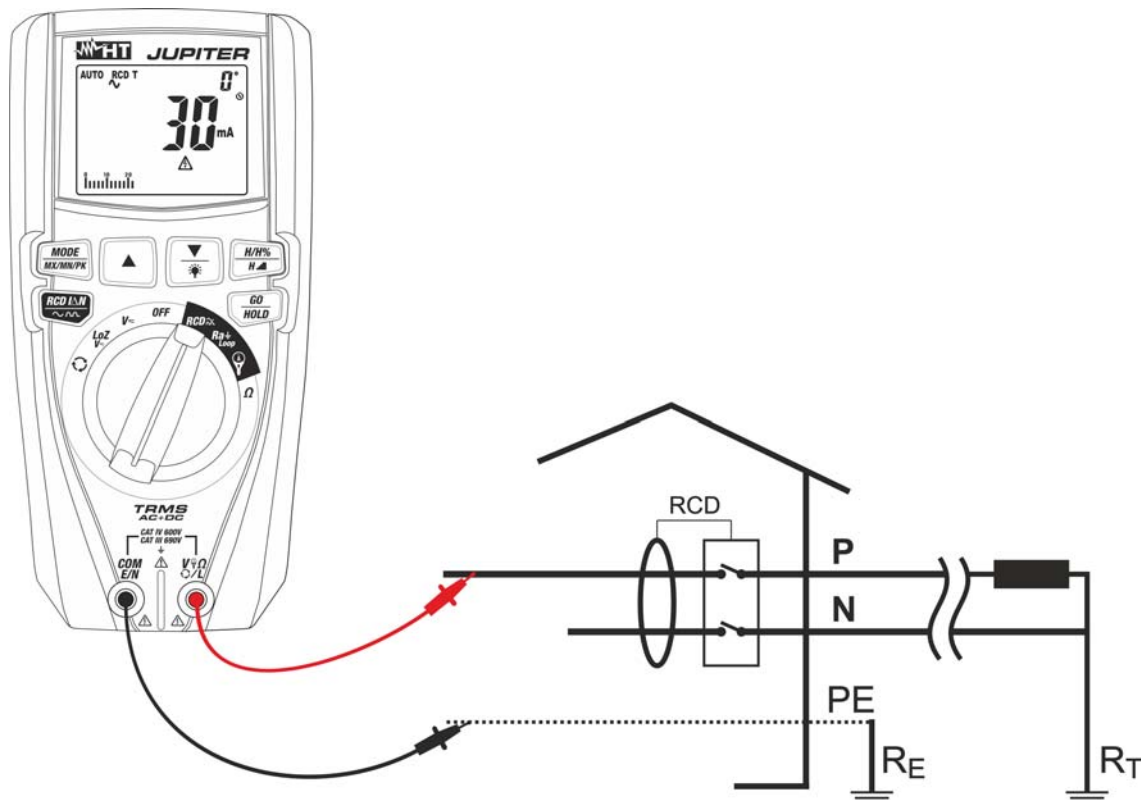

Fig. 30: Use of the instrument for RCD test on single-phase system with leads

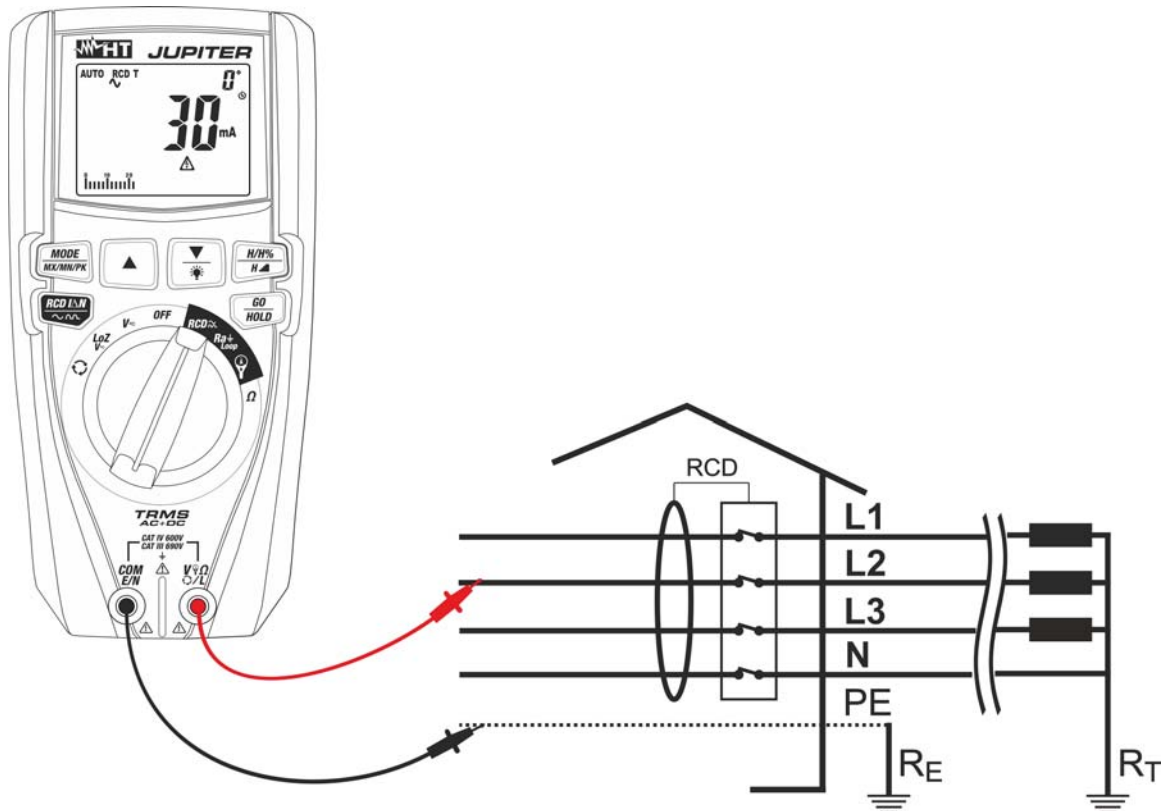

Fig. 31: Use of the instrument for RCD test on three-phase system with leads

1. Set the limit value of contact voltage (see § 4.2.10)
2. Select position **RCD**
3. Press key **MODE/MXMNPK** and select one of the following options:
 - Mode **AUTO RCD T** → Measurement of the RCD's tripping time in automatic sequence with test currents $I_{\Delta n}$, $5xI_{\Delta n}$, $\frac{1}{2}I_{\Delta n}$ and polarity 0° and 180° . See Table 1 in § 7.1 to identify possible combinations
 - Mode **RCD T $\frac{1}{2}I_{\Delta n}$** → Measurement of manual tripping time with test current $\frac{1}{2}I_{\Delta n}$ and polarity 0° and 180° . See Table 1 in § 7.1 to identify possible combinations
 - Mode **RCD T $I_{\Delta n}$** → Measurement of manual tripping time with test current $I_{\Delta n}$ and polarity 0° and 180°
 - Mode **RCD T $5xI_{\Delta n}$** → Measurement of manual tripping time with test current $5xI_{\Delta n}$ and polarity 0° and 180° . See Table 1 in § 7.1 to identify possible combinations
 - Mode **RCD** → Measurement of tripping current with increasing “ramp” method and polarity 0° and 180° (only AC and A RCDs with 30mA).
4. Press key **RCD $I_{\Delta n}$** to set the rated tripping time of the RCD among the options: **30mA, 100mA, 300mA**. See table in § to identify possible combinations
5. Press and hold (>2s) key **RCD $I_{\Delta n}$** to set the type of RCD among the options: (type AC) and (type A). See table in § to identify possible combinations
6. In case the cable with Shuko plug is used, insert the red conductor into input terminal **V Ω L** and the green conductor into input terminal **COM/E/N** and connect the instrument to the system to be tested (see Fig. 29). The presence of phase-to-earth voltage is shown in the bargraph
7. In case measuring leads are used, insert the red conductor into input terminal **V Ω L** and the black conductor into input terminal **COM/E/N** and connect the instrument to the system to be tested (see Fig. 30 or Fig. 31). The presence of phase-to-earth voltage is shown in the bargraph
8. Press key **GO/HOLD** to activate the test with polarity 0° . Press again **GO/HOLD** key with symbol flashes on the display to activate polarity 180° . The screens shown in Fig. 19, Fig. 20 and Fig. 21 may appear on the display for a few seconds to signal anomalous conditions in which the instrument does not carry out the test.
9. In case no anomalous conditions are present, the instrument carries out the test and symbol flashes on the display. During and at the end of the test, the following screens appear on the display:

Tripping time in automatic mode (AUTO) (6 tests in a sequence)

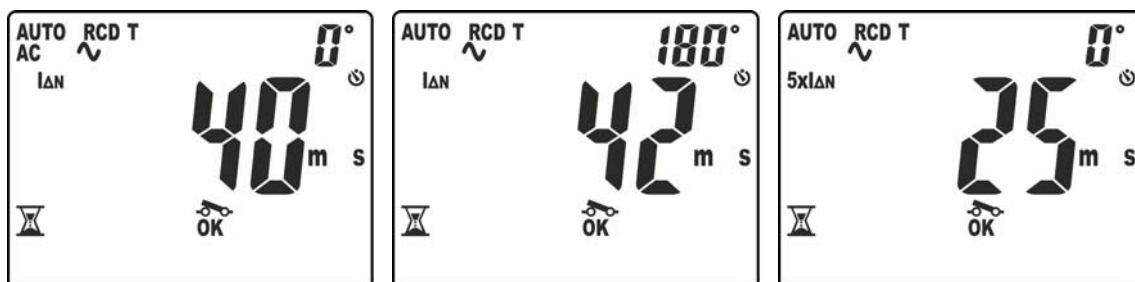

Fig. 32: Tripping time in AUTO mode – Screen 1

10. The first test carried out is the one with test current $I_{\Delta n}$ and polarity 0° . The result of partial measurement is shown on the display with indication "OK" or "NOT OK" (see Fig. 32 – left side). Symbol "⚡" flashing indicates that the RCD must be reset.
11. The second test carried out is the one with test current $I_{\Delta n}$ and polarity 180° . The result of partial measurement is shown on the display with indication "OK" or "NOT OK" (see Fig. 32 – middle). Symbol "⚡" flashing indicates that the RCD must be reset.
12. The third test carried out is the one with test current $5xI_{\Delta n}$ and polarity 0° . The result of partial measurement is shown on the display with indication "OK" or "NOT OK" (see Fig. 32 – right side). Symbol "⚡" flashing indicates that the RCD must be reset.

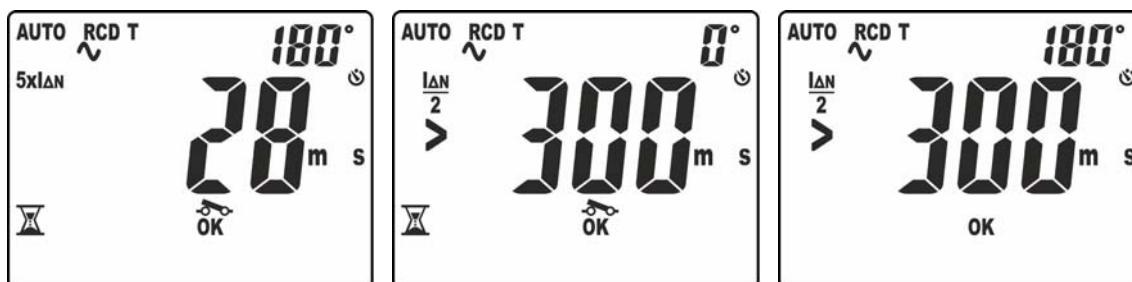

Fig. 33: Tripping time in AUTO mode – Screen 2

13. The fourth test carried out is the one with test current $5xI_{\Delta n}$ and polarity 180° . The result of partial measurement is shown on the display with indication "OK" or "NOT OK" (see Fig. 33 – right side). Symbol "⚡" flashing indicates that the RCD must be reset.
14. The fifth test carried out is the one with test current $\frac{1}{2}I_{\Delta n}$ and polarity 0° . The result of partial measurement is shown on the display with indication "OK" or "NOT OK" (see Fig. 33 – middle). Message ">300ms" indicates that the full scale of the instrument has been reached, to indicate that the RCD correctly did not trip in this situation. Symbol "⚡" flashing indicates that the RCD must be reset.
15. The sixth and last test carried out is the one with test current $\frac{1}{2}I_{\Delta n}$ and polarity 180° . The result of partial measurement is shown on the display (see Fig. 33 – right side). Message ">300ms" indicates that the full scale of the instrument has been reached, to indicate that the RCD correctly did not trip in this situation. Indication "OK" or "NOT OK" indicates in this case also the final result of the test
16. The "ALL OK" indication shows the final correct outcome of test

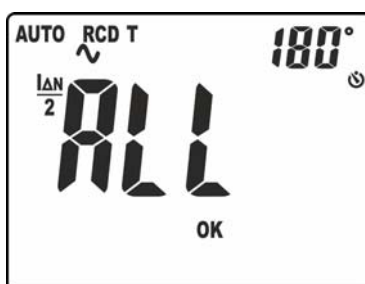

Fig. 34: Outcome final test screen

Tripping time in manual mode (test current $I_{\Delta n}$)

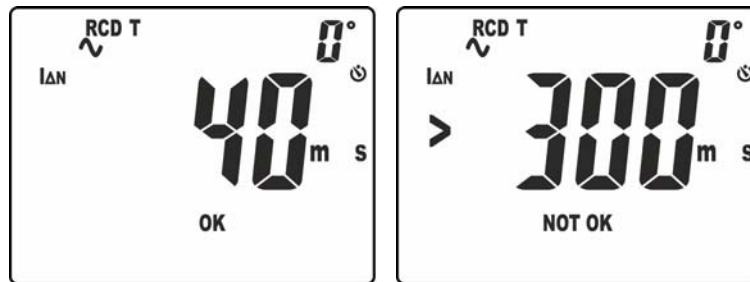

Fig. 35: Tripping time in manual mode at $I_{\Delta n}$

- 10. The correct measurement result is shown on the display (see Fig. 35 – left side) with indication “OK”
- 11. The correct measurement result is shown on the display (see Fig. 35 – right side) with indication “NOT OK”. The buzzer gives a short continuous sound

Tripping time in manual mode (test current $5xI_{\Delta n}$)

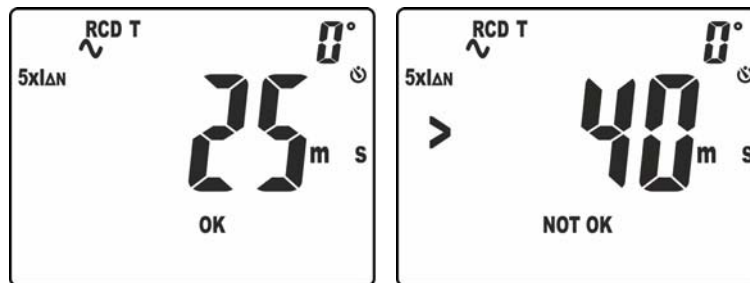

Fig. 36: Tripping time in manual mode at $5xI_{\Delta n}$

- 10. The correct measurement result is shown on the display (see Fig. 36 – left side) with indication “OK”
- 11. The wrong measurement result (**tripping time > 40ms**) is shown on the display (see Fig. 36 – right side) with indication “NOT OK”. The buzzer gives a short continuous sound

RCD tripping current

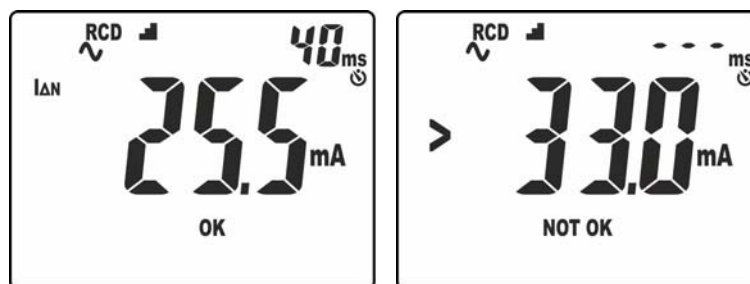

Fig. 37: RCD tripping current

- 10. The correct measurement result is shown on the display (see Fig. 36 – left side) with indication “OK”. Notice the presence of tripping time on the top of the display on the right side.
- 11. The wrong measurement result is shown on the display (see Fig. 36 – left side) with indication “NOT OK” (**tripping current > 33mA**). The buzzer gives a short continuous sound

5.9. DC, AC, AC+DC, INRUSH CURRENT WITH CLAMP TRANSDUCERS
CAUTION

- Maximum measurable current in this function is 3000A AC or 1000A DC. Do not measure currents exceeding the limits given in this manual.
- The instrument carries out the measurement both with flexible clamp transducer (optional accessories) and with other **standard** clamp transducers in the HT family (optional accessories). With transducers having an Hypertac output connector, the optional adapter NOCANBA is necessary to obtain the connection.

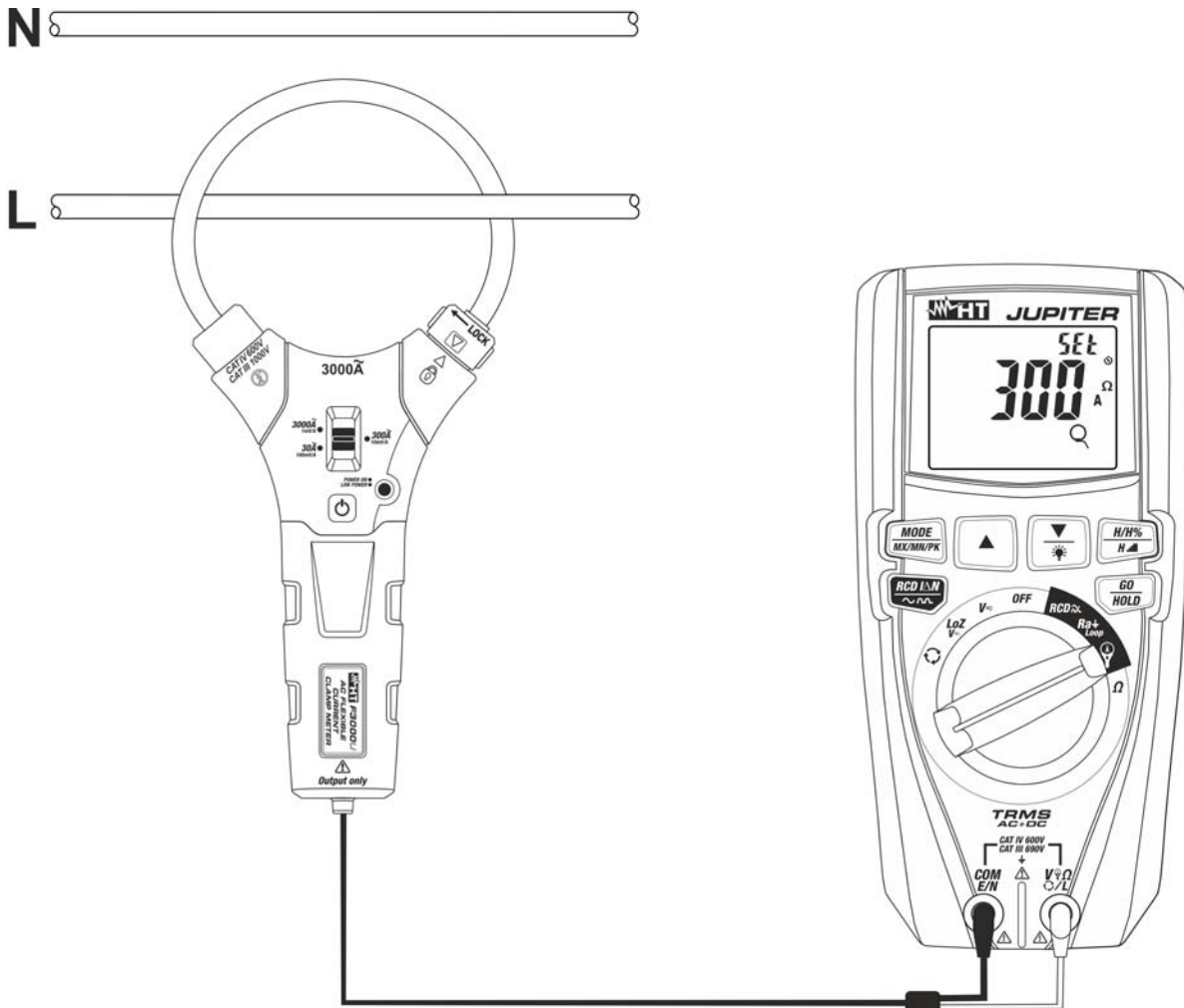

Fig. 38: Use of the instrument for current measurement with clamp transducer

1. Select the position
2. Press key **MODE/MXMPK** to select the type of clamp transducer among the options: “
3. Press the keys or or and, on the instrument, select the **same range** set on the clamp, among the options: **30A, 300A, 3000A** (AC current measurement with flexible clamp) or: **1A, 10A, 30A, 40A, 100A, 200A, 300A, 400A, 1000A, 2000A, 3000A** for AC, DC, AC+DC current measurement with standard clamp).
4. For flexible clamps transducer set the relative voltage full scale (see § 4.2.12)
5. Press key **GO/HOLD** to confirm settings.

6. For standard clamp transducers, press key **MODE/MXMNPK** to select “AC”, “DC” or “AC+DC” measurement. Anyway, the instrument automatically recognizes AC or DC quantities.
7. Insert the red cable into input terminal **VΩΩL** and the black cable into input terminal **COM/E/N**. For standard transducers (see §) with Hypertac connector, use optional adapter NOCANBA. For information on the use of clap transducers, please refer to the relevant user manual.
8. Insert the cable into the center of jaws (see Fig. 38). The value of current is shown in Fig. 39

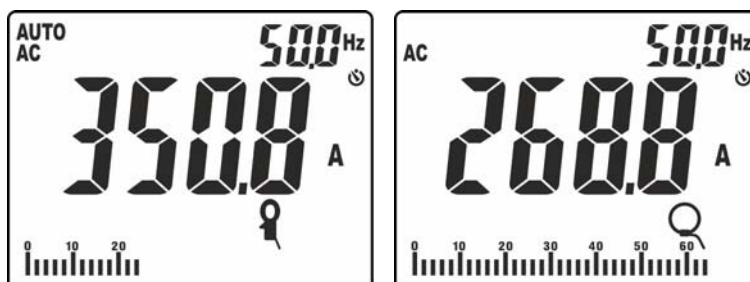

Fig. 39: Result of AC current measurement with standard and flexible clamp

9. Press key **MODE/MXMNPK** to display the value of frequency of AC current with a high resolution (see Fig. 40)

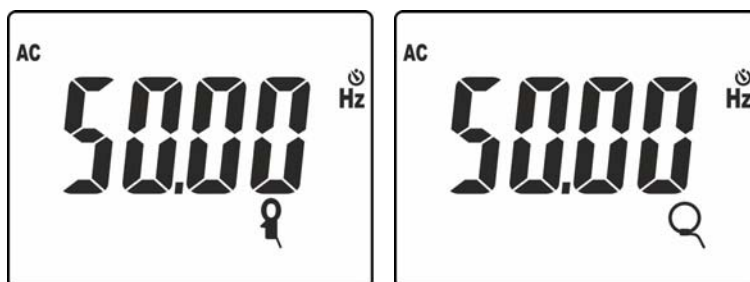

Fig. 40: Result of frequency measurement with standard and flexible clamp

10. The following screens may be shown on the display:



Fig. 41: Anomalous situations on current measurement with clamp transducers

11. Message “>300A” indicates that the value of current measured is higher than the set full scale (300A in case of Fig. 41). If the display shows the messages “<32.00Hz” or “>1000Hz”, the measured value of current frequency is out of the measuring range **32Hz ÷ 1000Hz**.
12. To use HOLD, MAX/MIN/PK, H/H%/H▬ functions, see § 4.2

INRUSH current measurement (DIRC)

CAUTION



- Maximum measurable current in this function is 3000A AC or 1000A DC. Do not measure currents exceeding the limits given in this manual.
- The instrument carries out the measurement both with flexible clamp transducers (optional accessories) and with other **standard** clamp transducers in the HT family (optional accessories). For inrush current with high DC component is **recommended** the use of AC/DC clamps. With transducers having an Hypertac output connector, the optional adapter NOCANBA is necessary to obtain the connection.

1. Select the position.
2. Press key **MODE/MXMNPK** to select the type of clamp transducer among the options: “Q” (optional flexible clamp transducer – only AC) or “A” (standard clamp transducer – AC or DC)
3. Press the keys $\nabla/\text{lightbulb}$ or \blacktriangle and, on the instrument, select the **same range** set on the clamp, among the options: **30A, 300A, 3000A** (AC current measurement with flexible clamp) or: **1A, 10A, 30A, 40A, 100A, 200A, 300A, 400A, 1000A, 2000A, 3000A** for AC, DC, AC+DC current measurement with standard clamp.
4. For flexible clamps transducer set the relative voltage full scale (see § 4.2.12)
5. Press key **GO/HOLD** to confirm settings.
6. Press key **MODE/MXMNPK** to select “IRC” measurement. The following screens are shown on the display according to the type of clamp used:

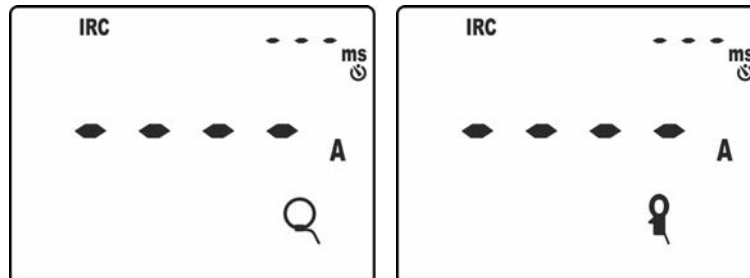

Fig. 42: Initial screens of inrush current measurement

7. connect the clamps to the system to be tested as indicated in § 5.9.
8. Press key **GO/STOP** to activate the function. The instrument waits for the event to be recognized (measured value higher than the fixed trigger threshold equal to **1%FS clamp: e.g. 30A with FS = 3000A**) and shows symbol “⌚” on the display (see Fig. 43 – left side)

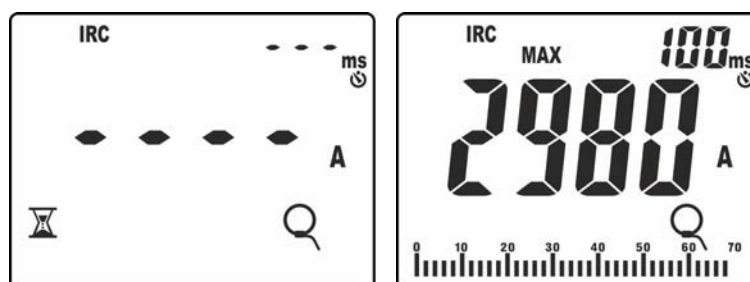

Fig. 43: Recognition of inrush current event

9. Upon recognition of the event, **measurement stops automatically** and the instrument shows, in its main display, the **Max RMS** value calculated according to the evaluation time of **100ms** (default) indicated on the secondary display (see Fig. 43 – right side)
10. Press keys \blacktriangledown / ⏏ or \blacktriangle to select the display of the following parameters:
 - Peak value “Pk” calculated in **1ms** (see Fig. 44 – left side)
 - Max RMS value calculated in **16.7ms**
 - Max RMS value calculated in **20ms**
 - Max RMS value calculated in **50ms**
 - Max RMS value calculated in **100ms**
 - Max RMS value calculated in **150ms**
 - Max RMS value calculated in **175ms**
 - Max RMS value calculated in **200ms**

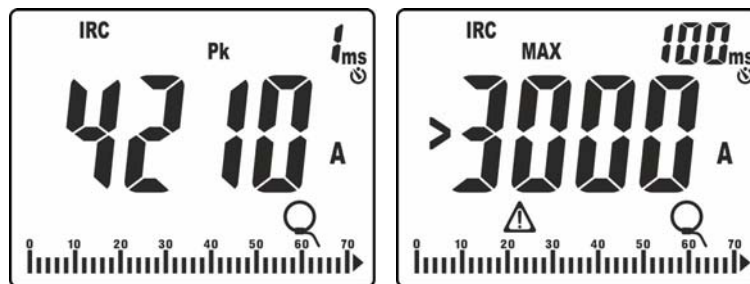

Fig. 44: Examples of display of inrush current

11. If the measured current is higher than the set FS of the clamp, a message like the one in Fig. 44 – right side (relevant to FS = 3000A) is shown on the display.
12. Press key **GO/HOLD** again to start a new measurement or turn the rotary switch to quit the function.

6. MAINTENANCE



CAUTION

- Only expert and trained technicians should perform maintenance operations. Before carrying out maintenance operations, disconnect all cables from the input terminals.
- Do not use the instrument in environments with high humidity levels or high temperatures. Do not expose to direct sunlight.
- Always switch off the instrument after use. In case the instrument is not to be used for a long time, remove the battery to avoid liquid leaks that could damage the instrument's internal circuits.

6.1. BATTERY REPLACEMENT

When the LCD display shows symbol “” and “bAtt” message (see), batteries need to be replaced, operating as follows:



Fig. 45: Low battery indications

1. Position the rotary switch to **OFF** and remove the cables from the input terminals.
2. Turn the fastening screw of the battery compartment cover from position “” to position “” and remove it.
3. Remove the battery and insert a new battery of the same type (see § 7.1.1), respecting the indicated polarity.
4. Restore the battery compartment cover into place and turn the fastening screw from position “” to position “”.
5. Do not scatter old batteries into the environment. Use the relevant containers for disposal.

6.2. CLEANING THE INSTRUMENT

Use a soft and dry cloth to clean the instrument. Never use wet cloths, solvents, water, etc.

6.3. END OF LIFE



WARNING: the symbol on the instrument indicates that the appliance and its accessories must be collected separately and correctly disposed of.

7. TECHNICAL SPECIFICATIONS

7.1. TECHNICAL CHARACTERISTICS

Accuracy calculated as [%reading + (no. digits*resolution)] at 23°C ±5°, <80%HR

DC Voltage (Autorange)

Range [V]	Resolution [V]	Accuracy	Input impedance	Overload protection
0.0 ÷ 690.0	0.1	±(0.5%rdg + 2digits)	1MΩ	690VDC/ACrms

AC, AC+DC, LoZ TRMS Voltage (Autorange)

Range [V]	Resolution [V]	Frequency	Accuracy	Protection against overcharge
0.5 ÷ 690.0	0.1	32Hz ÷ 1kHz	±(0.5%rdg + 2sigits)	690VDC/ACrms

Input impedance function VAC: 1MΩ,

Input impedance LoZ: 3.5kΩ for 10s (@ 110V/50Hz), 4.5s (@ 230V/50Hz), 1s (@ 400V/50Hz). For higher voltage values, the input impedance increase to 10kΩ. **CAUTION: do not leave the instrument connected for more than 1 minute**

Automatic selection DC mode, Max crest factor: 1.5

Current and voltage frequency (Autorange)

Range [Hz]	Resolution [Hz]	Accuracy
33.00 ÷ 99.99	0.01	±(0.1%rdg + 1digit)
100.0 ÷ 999.9	0.1	

Voltage range: 0.5V ÷ 690V, Current field: 0.5A ÷ 3000A (Flexible clamp F300U), 1mV ÷ 1000mV (STD clamp)

AC TRMS current (Flexible clamp F3000U) – (Autorange)

Range [mV]	Resolution [mV]	Accuracy (*)
1 ÷ 3000	1	±(0.5%rdg + 2digits)

(*) For frequency >100Hz the accuracy is: ±(1.5%rdg + 5dgt)

Max crest factor: Frequency bandwidth: 1kHz

AC TRMS Current (Flexible clamp FS 1V), DC, AC, AC+DC (STD clamp) – (Autorange)

Range [mV]	Resolution [mV]	Accuracy (*)
1 ÷ 1000	1	±(0.5%rdg + 2digits)

(*) For frequency >100Hz the accuracy is: ±(1.5%rdg + 5dgt)

Max crest factor: Frequency bandwidth: 1kHz

INRUSH AC TRMS Current (Flexible clamp F3000U)

Range [mV]	Resolution [mV]	Accuracy (*)
1 ÷ 3000	1	±(2%reading + 2digits)

(*) Accuracy declared for frequency: DC, 42.5 ÷ 69Hz

Max crest factor: 3, Sampling frequency: 4kHz

Response time: 1ms (Peak), 16.7ms, 20ms, 50ms, 100ms, 150ms, 175ms, 200ms (max RMS)

Detection trigger threshold: 1%FS clamp [A] fixed

INRUSH AC TRMS Current (Flexible clamp FS 1V), DC, AC, AC+DC (STD clamp)

Range [mV]	Resolution [mV]	Accuracy (*)
1 ÷ 1000	1	±(2%reading + 2digits)

(*) Accuracy declared for frequency: DC, 42.5 ÷ 69Hz

Max crest factor: 3, Sampling frequency: 4kHz

Response time: 1ms (Peak), 16.7ms, 20ms, 50ms, 100ms, 150ms, 175ms, 200ms (max RMS)

Detection trigger threshold: 1%FS clamp [A] fixed

Resistance and continuity test (Autorange)

Range [Ω]	Resolution [Ω]	Accuracy	Buzzer
0.0 ÷ 199.9	0.1	±(1.0%reading + 5digits)	<30Ω
200 ÷ 1999	1		

Harmonic voltage and current (Aurorange)

Harmonic order	Fundamental frequency	Resolution	Accuracy (*) (non-zeroed values)
DC	42.5Hz ÷ 69Hz	0.1V / 0.1A / 0.1%	±(5.0%rdg+20digits)
1 ÷ 25			±(5.0%rdg+10digits)
THD%		0.1%	±(10.0%rdg+10digits)

Accuracy of harmonic amplitudes expressed in % is evaluated considering the accuracy of parameters' ratio

(*) Harmonic voltages will be zeroed under the following conditions:

- 1st harmonic: value <0.5V
- DC, 2nd to 25th harmonic: harmonic value <0.5% fundamental value or value <0.5V

(*) Harmonic currents will be zeroed under the following conditions

- 1st harmonic: value <0.5%FS clamp [A]
- DC, 2nd to 25th harmonic: harmonic value <0.5% fundamental value or value <0.5%FS clamp [A]

Loop impedance L-N, L-L, $R_{a\frac{1}{2}}$, $R_{a\frac{1}{2}}RCD$ (no RCD tripping)

L-PE, L-N, L-L voltage: 100V ÷ 690V, 42.5 ÷ 69Hz

Test current: (see table below)

Test	Test current	Range [Ω]	Resolution [Ω]	Accuracy
$R_{a\frac{1}{2}}RCD$	15mA	1 ÷ 1999	1	-0%,+(5.0%rdg + 3 Ω)
L-N, L-L, $R_{a\frac{1}{2}}$	100mA	0.1 ÷ 199.9	0.1	-0%,+(5.0%rdg + 0.3 Ω)

Test on RCD (instantaneous molded-case type)

Residual current protection type (RCD): AC (\sim), A (\sim), General (G)

L-PE, L-N voltage: 100V ÷ 690V, 42.5 ÷ 69Hz

Tripping currents ($I_{\Delta N}$): 30mA, 100mA, 300mA (see Table 1)

Tripping time: resolution: 1ms, accuracy: ±(2.0%rdg + 2digits)

Tripping times for moulded-case type RCDs
(n.a. = function not available)

		x 1/2 G	x 1 G	x 5 G	G	AUTO G
30mA	AC	300	310	40	310	x1 x5 x½
	A	300	310	40	310	x1 x5 x½
100mA	AC	300	310	n.a.	n.a.	x1 x½
	A	300	310	n.a.	n.a.	x1 x½
300mA	AC	300	310	n.a.	n.a.	x1 x½
	A	300	310	n.a.	n.a.	x1 x½

Table 1: Possible combinations and tripping time duration [ms]

Tripping current (Ramp)

Type	$I_{\Delta N}$	Ramps [LCD]	Current value [mA RMS @20ms]	Accuracy
AC	30mA	6.0, 6.5, 7.0 .. 32.5, 33.3	6.0, 6.5, 7.0 .. 32.5, 33.0	- 0%, +5% $I_{\Delta N}$
A	30mA	6.0, 6.5, 7.0 .. 32.5, 33.3	8.5, 9.2, 9.9 .. 46, 46.7	- 0%, +5% $I_{\Delta N}$

Phase sequence with 1 terminal (*)

Voltage range L-N, L-PE, L-L [V]	Frequency range
130 ÷ 690	42.5 ÷ 69Hz

(*) Measurement possible by direct contact on the metallic parts of the conductors (not on the insulating sheath)

Reference standards





Instrument safety:	IEC/EN61010-1, IEC/EN61010-2-030, IEC/EN61010-2-033
EMC:	IEC/EN 61326-1
Test RCD:	IEC/EN61557-6
Test LOOP P-P, P-N, P-PE, $R_{a\perp}$:	IEC/EN61557-3
Phase sequence:	IEC 61557-7
Insulation:	double insulation
Pollution level:	2
Measurement category:	CAT IV 600V, CAT III 690V to earth and between inputs

7.1.1. General characteristics

Mechanical characteristics

Size (L x W x H):	175 x 85 x 55mm (7 x 3 x 2in)
Weight (batteries included):	420g (15 ounces)
Mechanical protection:	IP40

Power supply

Battery type:	4x1.5V batteries type AAA IEC LR03
Low battery indication:	symbol  on the display
Battery life:	V, A, Ω ,  → approx. 132h (backlight OFF) V, A, Ω ,  → approx. 68h (backlight ON) $R_{a\perp}$ (15mA) → approx. 5400 tests (backlight ON) $R_{a\perp}$ (100mA) → approx. 13k tests (backlight ON) RCD  → approx. 8600 tests (backlight ON) RCD T → approx. 160k tests (backlight ON)

Auto Power Off: after 15 minutes' idling (can be disabled)

Display

Type of display:	4 dgt LCD, max 9999 dots, decimal sign, point backlight and bargraph, indication of polarity
Sampling frequency:	2 times/s
Conversion:	RMS

7.2. ENVIRONMENTAL CONDITIONS FOR USE

Reference temperature:	23°C ± 5°C (73°F ± 41°F)
Operating temperature:	5°C ÷ 40°C (41°F ÷ 104°F)
Allowable relative humidity:	<80%RH
Storage temperature:	-20°C ÷ 60°C (-4°F ÷ 140°F)
Storage humidity:	<80%RH
Max operating altitude:	2000m (6562ft)

**This instrument satisfies the requirements of Low Voltage Directive 2014/35/EU (LVD) and of EMC Directive 2014/30/EU
This instrument satisfies the requirements of European Directive 2011/65/EU (RoHS) and 2012/19/EU (WEEE)**

7.3. ACCESSORIES

See the attached packing list.

8. ASSISTANCE

8.1. WARRANTY CONDITIONS

This instrument is warranted against any material or manufacturing defect, in compliance with the general sales conditions. During the warranty period, defective parts may be replaced. However, the manufacturer reserves the right to repair or replace the product. Should the instrument be returned to the After-sales Service or to a Dealer, transport will be at the Customer's charge. However, shipment will be agreed in advance. A report will always be enclosed to a shipment, stating the reasons for the product's return. Only use original packaging for shipment. Any damage due to the use of non-original packaging material will be charged to the Customer. The manufacturer declines any responsibility for injury to people or damage to property.

The warranty shall not apply in the following cases:

- Repair and/or replacement of accessories and battery (not covered by warranty).
- Repairs that may become necessary as a consequence of an incorrect use of the instrument or due to its use together with non-compatible appliances.
- Repairs that may become necessary as a consequence of improper packaging.
- Repairs which may become necessary as a consequence of interventions performed by unauthorized personnel.
- Modifications to the instrument performed without the manufacturer's explicit authorization.
- Use not provided for in the instrument's specifications or in the instruction manual.

The content of this manual cannot be reproduced in any form without the manufacturer's authorization.

Our products are patented and our trademarks are registered. The manufacturer reserves the right to make changes in the specifications and prices if this is due to improvements in technology.

8.2. ASSISTANCE

If the instrument does not operate properly, before contacting the After-sales Service, please check the conditions of battery and cables and replace them, if necessary. Should the instrument still operate improperly, check that the product is operated according to the instructions given in this manual. Should the instrument be returned to the After-sales Service or to a Dealer, transport will be at the Customer's charge. However, shipment will be agreed in advance. A report will always be enclosed to a shipment, stating the reasons for the product's return. Only use original packaging for shipment; any damage due to the use of non-original packaging material will be charged to the Customer.

9. THEORETICAL APPENDIXES

9.1. TEST ON DIFFERENTIAL SWITCHES (RCD)

Purpose of the test

Checking standards that the general differential protection devices (G) have been correctly installed and adjusted and that they maintain their characteristics over time. This check must make sure that the RCD trips at a current non higher than its rated operating current I_{dN} and that the tripping time **does not exceed the maximum time indicated in the standard for general RCDs (according to the description in Table 2)**.

The differential switch test performed with the test key helps so that no “gluing effect” jeopardizes the operation of the device if it has remained unused for a long time. This test is only performed to ascertain the mechanical functionality of the device and it is not sufficient to declare the device’s conformity to the standard regarding differential current devices. According to statistics, switch verification through test key, if performed once a month, reduces to a half the device’s malfunction rate. However, this test only detects 24% of the defective differential switches.

Parts of the system to be checked

All differential switches must be tested upon installation. In low-voltage systems, it is advisable to perform this test, fundamental in order to guarantee a correct safety level. In medical rooms, this test must be performed periodically every six months on all differential switches as prescribed by standards.

Allowable values

Two tests must be performed on each moulded-case type RCD: a test with a leakage current beginning in phase with the positive half-wave of voltage (0°) and a test with a leakage current beginning in phase with the negative half-wave of voltage (180°). The result to be considered is the higher one. The test with $\frac{1}{2}I_{dN}$ must not cause the tripping of the differential switch.

RCD type	$I_{dN} \times 1$	$I_{dN} \times 5$	Description
General	0.3s	0.04s	Maximum tripping time in seconds

Table 2: Tripping times for general moulded-case type RCDs

Measurement of tripping current for protection differential switches

- The purpose of this measurement is to check the real tripping current of general differential switches (**does not apply to selective differential switches**).
- For differential switches with fixed differential current, this test may be performed in order to detect possible leakages of the users connected to the system.
- Should an earth system not be available, perform the test by connecting the instrument to a terminal on a conductor downstream of the differential device and a terminal on the other conductor upstream of the device.
- Tripping current must be in the range between $\frac{1}{2}I_{\Delta N}$ and $I_{\Delta N}$.

9.2. OVERALL EARTH RESISTANCE IN TT SYSTEMS

Purpose of the test

Checking that the protection device is coordinated with the value of earth resistance. We cannot assume a priori a reference limit value for earth resistance as a reference when checking measurement results. It is necessary to check each time that the coordination prescribed by the standard is met.

Parts of the system to be checked

Earth installation in operating conditions. The test must be performed without disconnecting the earth plates.

Allowable values

The value of overall earth resistance, however measured, must satisfy the following relationship:

$$R_A < 50 / I_a$$

where:

- I_a = tripping current of the automatic RCD or rated tripping current of RCD $I_{\Delta n}$ expressed in A
- 50 = Safety limit contact voltage (reduced down to 25V in special environments)

EXAMPLE OF EARTH RESISTANCE CHECK

System protected by a 30mA differential switch.

- Measurement of overall earth resistance
- In order to understand if the system resistance is to be considered as compliant with the standards, we need to multiply the value found by 0.03A (30mA).
- If the result is lower than 50V (or 25V for special environments), the system can be considered as coordinated, as it satisfies the relationship indicated above.

When dealing with 30mA differential switches (as in almost all civil systems), the maximum allowable earth resistance is $50/0.03=1666\Omega$. This enables using also the indicated simplified methods which, although they do not provide an extremely precise value, provide a sufficiently approximated value to calculate coordination.

9.3. LOOP AND CALCULATION OF ASSUMED SHORT-CIRCUIT CURRENT

Purpose of the test

“Fault ring” (Loop) indicates the circuit run through by the current generated by an insulation fault to earth (dead short). The fault ring includes:

- The phase winding of the transformer.
- The line conductor, up to the fault point.
- The protective conductor from the fault point to the star center of the transformer.

Once impedance has been measured, it is possible to determine the earth dead short current (assumed short-circuit current **I_{sc}**) and to evaluate whether the protection devices against overcurrents are correctly coordinated for protection against indirect contacts.

Parts of the system to be checked

The test must necessarily be performed on TN and IT systems not protected with differential devices.

Allowable values

The purpose of this measurement is to check that the tripping current of the automatic protection device **I_a** satisfies one of the following relationships:

$$I_a \leq I_{SC} = \frac{U_{L-PE}}{Z_{LPE}} \quad \text{For measuring Line/Loop L-PE impedance}$$

$$I_a \leq I_{SC} = \frac{U_{L-N}}{Z_{LN}} \quad \text{For measuring Line/Loop L-N impedance}$$

$$I_a \leq I_{SC} = \frac{U_{L-L}}{Z_{LL}} \quad \text{For measuring Line/Loop L-L impedance}$$

where:

U_{L-PE}	=	Rated voltage L-PE set on the instrument (see § 4.2.11)
U_{L-N}	=	Rated voltage L-N set on the instrument (see § 4.2.11)
U_{L-L}	=	Rated voltage L-L set on the instrument (see § 4.2.11)
Z_{LPE}	=	Loop impedance L-PE measured by the instrument
Z_{LN}	=	Loop impedance L-N measured by the instrument
Z_L	=	Loop impedance L-L measured by the instrument
I_{SC}	=	Assumed short-circuit current measured by the instrument

9.4. VOLTAGE AND CURRENT HARMONICS

Any periodic non-sinusoidal wave may be represented by a sum of sinusoidal waves, each with a frequency which is a whole multiple of the fundamental, according to the relationship:

$$v(t) = V_0 + \sum_{k=1}^{\infty} V_k \sin(\omega_k t + \varphi_k) \quad (1)$$

where: V_0 = Average value of $v(t)$
 V_1 = Amplitude of the fundamental of $v(t)$
 V_k = Amplitude of the k -nth harmonic of $v(t)$

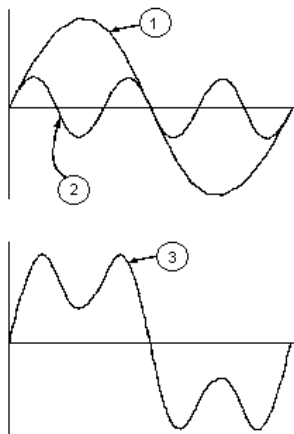

CAPTION:

1. Fundamental
2. Third Harmonic
3. Distorted waveform sum of two components

Fig. 46: Effect of overlapping of two frequencies, one multiple of the other

For network voltage, the fundamental has a frequency of 50Hz, the second harmonic has a frequency of 100 Hz, the third harmonic has a frequency of 150Hz and so on. Harmonic distortion is a continuous problem and must not be confused with short-duration phenomena such as peaks, drops or fluctuations. It can be seen from (1) that each signal consists of the summation of infinite harmonics. However, an order number exists beyond which the value of the harmonics may be considered as negligible. Standard EN50160 suggests cutting the summation in the expression (1) at the 40th harmonic. A fundamental index to detect the presence of harmonics is the THD% (Total Harmonic Distortion) defined as:

$$THD\% = \frac{\sqrt{\sum_{h=2}^{40} V_h^2}}{V_1} \times 100$$

This index takes into consideration the presence of all harmonics, and the more distorted is the waveform, the higher is the index.

Limit values for harmonics

Standard EN50160 prescribes the limits for the Harmonic voltages the Supplier may put in network. In normal operating conditions, at any time in a week, 95% of the efficient values of each harmonic voltage, averaged to 10 minutes, must be lower than or equal to the values indicated in Table 3. The overall harmonic distortion (THD%) of supply voltage (including all harmonics up to the 40th) must be lower than or equal to 8%.

Odd Harmonics				Even Harmonics	
Not multiple of 3		Multiple of 3		Order h	Relative Voltage %Max
Order h	Relative Voltage %Max	Order h	Relative Voltage %Max		
5	6	3	5	2	2
7	5	9	1.5	4	1
11	3.5	15	0.5	6..24	0.5
13	3	21	0.5		
17	2				
19	1.5				
23	1.5				
25	1.5				

Table 3: Limits for the harmonic voltages the supplier may introduce into the network.

These limits, which theoretically apply only to Electric Power Suppliers, anyway provide a series of reference values within which also the harmonics put into network by users should be kept.