



GEO416 GEO416GS

User manual

CE



Table of contents:

1. SAFETY PRECAUTIONS AND PROCEDURES	2
1.1. Preliminary instructions	2
1.2. During use	3
1.3. After use	3
1.4. Definition of measurement category (Overvoltage).....	3
2. GENERAL DESCRIPTION	4
2.1. Instrument description	4
3. PREPARING THE INSTRUMENT	4
3.1. Initial check.....	4
3.2. Power supply	4
3.3. Calibration	4
3.4. Storage.....	4
4. WORKING INSTRUCTIONS	5
4.1. Instrument description	5
4.2. MEASURING ACCESSORIES DESCRIPTION	5
Fig. 2: Measuring accessories description.....	5
4.2.1. Switching on.....	6
4.2.2. Auto power off.....	6
4.3. EARTH 3W – 3 wire earth resistance measurement.....	7
4.4. EARTH 2W – 2 wire earth resistance measurement.....	9
4.5. ρ - Ground resistivity measurement	12
4.5.1. Anomalous measuring applications	15
5. MANAGEMENT OF STORED DATA.....	17
5.1. How to save a measurement.....	17
5.2. how to cancel one or several measurements.....	17
5.3. How to recall a measurement.....	18
6. INSTRUMENT RESET	19
7. INSTRUMENT CONNECTION TO PC	19
8. MAINTENANCE	20
8.1. General.....	20
8.2. Battery replacement	20
8.3. Instrument cleaning	20
8.4. End of life	20
9. TECHNICAL SPECIFICATIONS	21
9.1. Technical features	21
9.1.1. Reference standards.....	22
9.1.2. General features	22
9.2. Environment	22
9.2.1. Operating environmental conditions	22
9.3. Accessories	22
9.3.1. Standard and optional accessories GEO416.....	22
9.3.2. Standard accessories GEO416GS	22
10. SERVICE.....	23
10.1. Warranty terms.....	23
10.2. After-sales service.....	23
11. PRACTICAL REPORTS FOR ELECTRICAL TESTS	24
11.1. Earth resistance in tt systems	24
11.2. Earth resistance, voltaamperometric method.....	25
11.2.1. Creating cables extensions.....	25
11.2.2. Method for small-sized earth rods.....	25
11.2.3. Method for large-sized earth rods.....	25
11.3. Ground resistivity.....	26
11.3.1. Approximate evaluation of intentional rods' contribution	27

1. SAFETY PRECAUTIONS AND PROCEDURES

The instrument was designed in compliance with standards IEC/EN61557 and IEC/EN61010-1 relative to electronic equipment.

CAUTION



For your own safety and to avoid damaging the instrument you are recommended to follow the procedures described in this manual and read carefully all instructions preceded by this symbol 

Before and during measurements keep to the following instructions:

- Do not take measurements in wet places as well as in the presence of explosive gas and combustibles or in dusty places
- Even though you are not taking any measurement avoid any contact with the circuit under test, with exposed metal parts, unused measuring terminals, circuits etc
- Do not take any measurement whenever anomalous conditions occur such as deformations, breaks, leakages, blind display etc
- Pay utmost attention when taking measurements of voltage higher than 25V in special places (building yards, swimming pools, etc.) and higher than 50V in ordinary places due to the risk of electric shock.

The following symbols are used in this manual as well as on the instrument:



CAUTION: Please read carefully this manual in order to understand the nature of the potential danger and the actions to undertake

Refer to the instruction manual. An improper use may damage the instrument or its components as well as endanger the user



DC or AC voltage and current



High voltage danger: risk of electric shock



Double insulation

1.1. PRELIMINARY INSTRUCTIONS

- This instrument was designed for use in environments with pollution degree 2
- It can be used for voltage and current measurements on electrical installations with CAT III 240V to earth and maximum voltage of 415V between inputs
- You are recommended to respect the usual safety regulations aimed at protecting you against dangerous currents and the instrument against improper use
- Only the original accessories supplied along with the instrument guarantee compliance with the safety standards in force. They must be in a good condition and, if necessary, replaced with identical ones
- Do not test nor connect to any circuit exceeding the specified overload protection
- Do not take measurements under environmental conditions exceeding the limits indicated in this manual
- Make sure that batteries are correctly installed
- Before connecting test leads to the circuit under test check that the right function was selected.

1.2. DURING USE

You are recommended to read carefully the following instructions:



CAUTION

Failure to comply with warnings and instructions may damage the instrument and/or its components as well as injure the operator. If the low battery symbol is displayed during use interrupt testing and replace batteries following the procedure described in § 8.2

- Before selecting a new function disconnect the test leads from the circuit under test
- When the instrument is connected to the circuit under test never touch any unused terminal
- Do not measure resistance in the presence of external voltages; although the instrument is protected, an excessive voltage may cause malfunction
- Avoid submitting the instrument to voltage while measuring (i.e. a test lead slipping off the measuring point accidentally touching an energized point).

1.3. AFTER USE

- Turn off the instrument pressing **ON/OFF** key after using it
- If you expect not to use the instrument for a long time remove the batteries.

1.4. DEFINITION OF MEASUREMENT CATEGORY (OVERVOLTAGE)

The standards IEC/EN61010-1: Safety requirements for electrical equipment for measurement, control and laboratory use, Part 1: General requirements, define what a measurement category, usually called over voltage category, means. Under § 6.7.4: Measuring circuits, it quotes:

Circuits are divided into the following measurement categories:

- **Measurement category IV** is for measurements performed at the source of a low-voltage installation.
Examples are electricity meters and measurements on primary excess current protection devices as well as ripple control units.
- **Measurement category III** is for measurements performed in the building installations.
Examples are measurements on distribution boards, circuit breakers, wiring, including cables, bus-bars, junction boxes, switches, socket-outlets in the fixed installations, and equipment for industrial use as well as some other equipment, for example, stationary motors with permanent connection to fixed installations.
- **Measurement category II** is for measurements performed on circuits directly connected to the low voltage installations.
Examples are measurements on household appliances, portable tools and similar equipment.
- **Measurement category I** is for measurements performed on circuits not directly connected to MAINS.
Examples are measurements on circuits not derived from MAINS, and specially (internally) protected MAINS-derived circuits. In this latter case, transient stresses are variable; for this reason, the norm requires that the transient withstanding capability of the equipment is made known to the user.

2. GENERAL DESCRIPTION

This instrument will grant you accurate and reliable measurements provided that is used according to the instructions given in this manual. You will enjoy the highest safety thanks to a development of newest conception assuring double insulation and over voltage category III.

2.1. INSTRUMENT DESCRIPTION

- **EARTH 2W:** 2-wire earth resistance measurement
- **EARTH 3W:** 3-wire earth resistance measurement
- **ρ :** 4-wire ground resistivity measurement.

3. PREPARING THE INSTRUMENT



3.1. INITIAL CHECK

This instrument was checked both mechanically and electrically prior to shipment. All possible cares and precautions were taken to let you receive the instrument under perfect conditions.

Notwithstanding we suggest you to check it rapidly to check any damage which may have occurred during transport. Should it be the case please contact immediately the forwarder or your dealer.

Make sure that all standard accessories mentioned in the enclosed packing list (see § 9.3) are included in the packaging. In case of discrepancies contact your dealer. Should you have to return back the instrument for any reason please follow the instructions mentioned under § 10.

3.2. POWER SUPPLY

The instrument is powered by batteries (see § 9.1.2). The battery charge is displayed on the right top side. The symbol  indicates that batteries are fully charged, while the symbol  indicates that batteries are low and shall be replaced.

To replace/insert batteries follow the instructions indicated under § 8.2.

3.3. CALIBRATION

The instrument complies with the technical specifications reported in this manual and such a compliance is guaranteed for one year after purchase date.

3.4. STORAGE

After a period of storage under extreme environmental conditions exceeding the limits let the instrument resume normal measuring conditions before using it (see § 9.2.1). This precaution will grant accurate measurements without risking to damage the instrument.

4. WORKING INSTRUCTIONS

4.1. INSTRUMENT DESCRIPTION



CAPTION:

1. Inputs
2. **ENTER**/**▲**,**▼**,**◀**,**▶** keys
3. **ESC**/**☀** key
4. **RCL/CLR** key
5. Display
6. **GO** key
7. **SAVE** key
8. **ON/OFF** key

Fig. 1: Instrument's description



ENTER key to select measuring mode

Arrow keys to move the cursor selecting the required parameters



☀ key to turn on the display backlight for 30 seconds

ESC key to quit without selecting any mode



RCL key to recall data stored in the instrument's memory

CLR key to cancel the selected measurements from the instrument's memory



GO key to start a measurement



SAVE key to store measurements



ON/OFF key to turn on/off the instrument

4.2. MEASURING ACCESSORIES DESCRIPTION

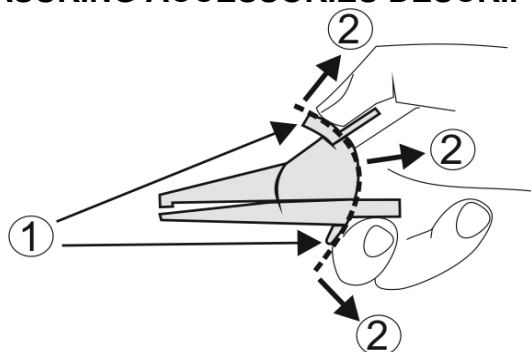

CAPTION:

1. Barrier
2. Hand-Held Area

Fig. 2: Measuring accessories description

4.2.1. Switching on

When switching on the instrument a brief tone is audible along with display of all segments for about one second.

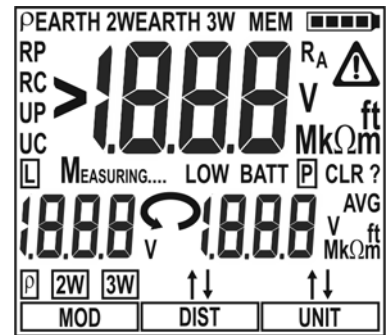

Subsequently the last firmware version as well as the last selected measuring mode are displayed before switching off.



4.2.2. Auto power off

The instrument automatically turns off 3 minutes after the last key pressing. To resume operation turn on the instrument pressing the on/off key.

4.3. EARTH 3W – 3 WIRE EARTH RESISTANCE MEASUREMENT

The measurement is carried out in compliance with standards IEC 781, VDE 0413, IEC/EN61557-5.

CAUTION



- The instrument can be used for voltage and current measurements on installations with over voltage category CAT III 240V to earth and maximum voltage of 415V between inputs. Do not connect the instrument to installations whose voltages exceed the limits indicated in this manual. Exceeding such limits may cause electric shock to the user and damage the instrument
- Always connect the cables to the instrument and to the alligator clips when the latter are not connected to the plant under test
- Always respect the Hand-held area of probe (see § 4.2)
- If the length of the supplied cables isn't suitable for the plant under test (see § 11), You can create your own extensions following indications in § 11.2.1

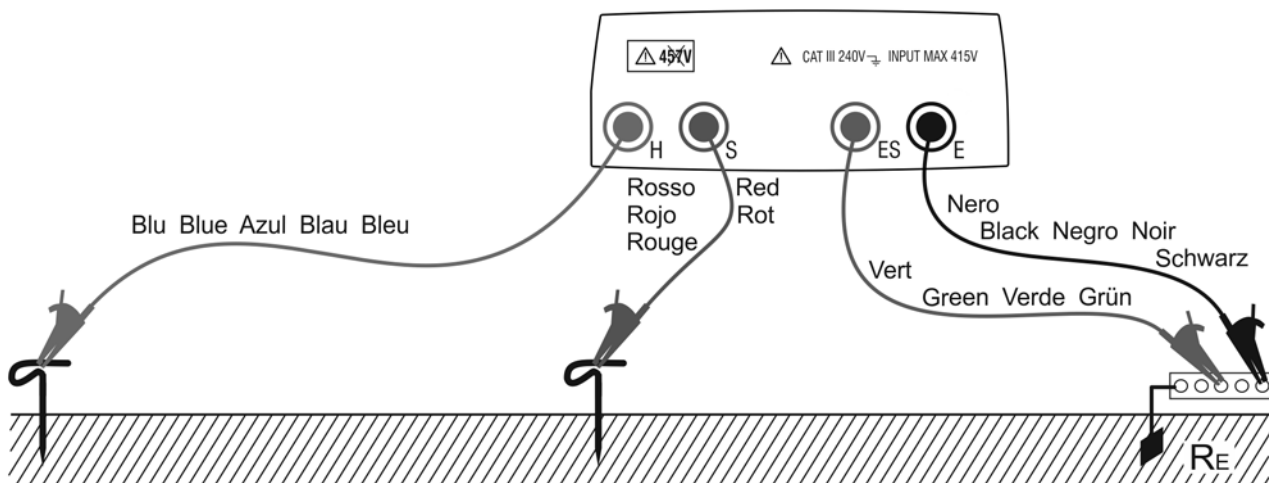



Fig. 3: Three-wire earth resistance measurement

1. Turn on the instrument pressing the ON/OFF key
2. Pressing right/left arrow keys ◀, ▶ select **MOD**, then pressing up/down arrow keys ▲, ▼ select **3W** option
3. A screen similar to the one beside appears where the input interfering voltage value of the instrument is displayed
4. Connect the blue, red, green and black cables to the corresponding instrument's input terminals H, S, ES, E then adding crocodiles if necessary

5. Extend, if necessary, the blue and red measuring cables separately using cables with proper section. Adding any extension does not require calibration and does not affect the measured earth resistance value
6. Drive the auxiliary rods into the ground keeping to the distance instructions provided by the standards (§ 11.2)
7. Connect crocodiles to the auxiliary rods and to the installation under test (see Fig. 3)

8.  Press **GO** key, the instrument starts carrying out measurement

9. While the instrument is measuring a screen similar to the one beside appears where the instrument's input interfering voltage value is displayed. When the message **MEASURING....** is displayed do not disconnect or touch the test leads

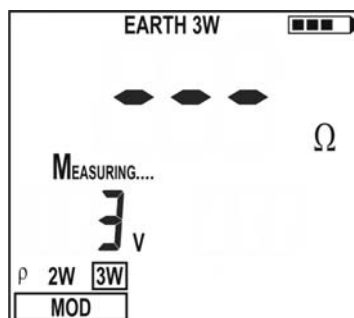

Input interfering voltage value

CAUTION



When starting measurement the input interfering voltage is measured at both the volt and ampere circuit. Should it range between 3 V and 9 V, the instrument carries out measurement and displays the symbol  indicating the uncertainty decline of the measurement (§ 9.1)

10. When the test is over, should the earth resistance value be lower than the full scale, the instrument emits a double tone indicating the positive outcome of the test and displays the resistance measurement as well as the interfering voltage value at the time of measuring

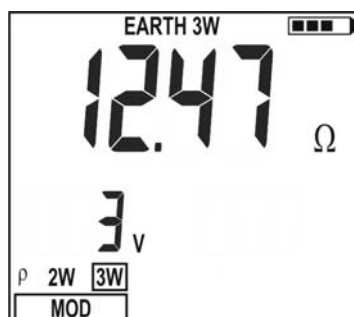

Earth resistance measurement

Input interfering voltage value

CAUTION



The resistance measurement is effected with 4-wire volt ampere method without being affected by the resistance value of the cables. It is therefore not necessary to effect compensation of cable resistance or of any extension

11. When the test is over, should the earth resistance value be higher than the full scale, the instrument emits a long tone indicating the negative outcome of the test and displays the screen beside

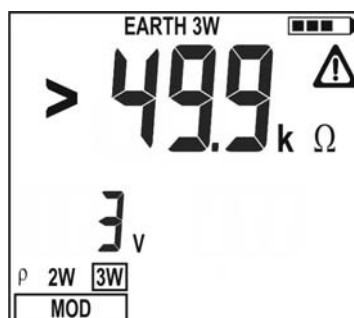

Earth resistance value higher than full scale

Input interfering voltage value

12.  The measurements can be stored pressing the **SAVE** key twice (§ 5.1)

4.4. EARTH 2W – 2 WIRE EARTH RESISTANCE MEASUREMENT

CAUTION



- The instrument can be used for voltage and current measurements on installations with over voltage category equal to CAT III 240V to earth and maximum voltage of 415V between inputs. Do not connect the instrument to installations whose voltages exceed the limits indicated in this manual. Exceeding such limits may cause electric shock to the user and damage the instrument
- Always connect the cables to the instrument and to the alligator clips when the latter are not connected to the plant under test
- Always respect the Hand-held area of probe (see § 4.2)
- If the length of the supplied cables isn't suitable for the plant under test (see § 11), You can create your own extensions following indications in § 11.2.1

Whenever it is not possible to drive rods into the ground to take a three-wire measurement (i.e. historical centres), it is possible to use the simplified two-wire method which gives an excess value for the sake of safety. To carry out the test a suitable auxiliary rod is necessary; an auxiliary rod is deemed as suitable when its earth resistance is negligible and independent of the earth installation under test.

In Fig. 4 a lamp post is used as auxiliary rod, however any metal body driven into the ground can be used provided that the above mentioned requirements are met.

CAUTION



The instrument displays the sum value of $R_A + R_T$ as result (see Fig. 4 and Fig. 5). Therefore the measurement achieved is the closer to R_A (prospective value) the more negligible is the value R_T of the auxiliary rod with respect to R_A itself. In addition the measurement will be increased "for safety sake" by R_T , i.e. if $R_A + R_T$ results to be coordinated with protective conductors, R_A alone will be far more coordinated

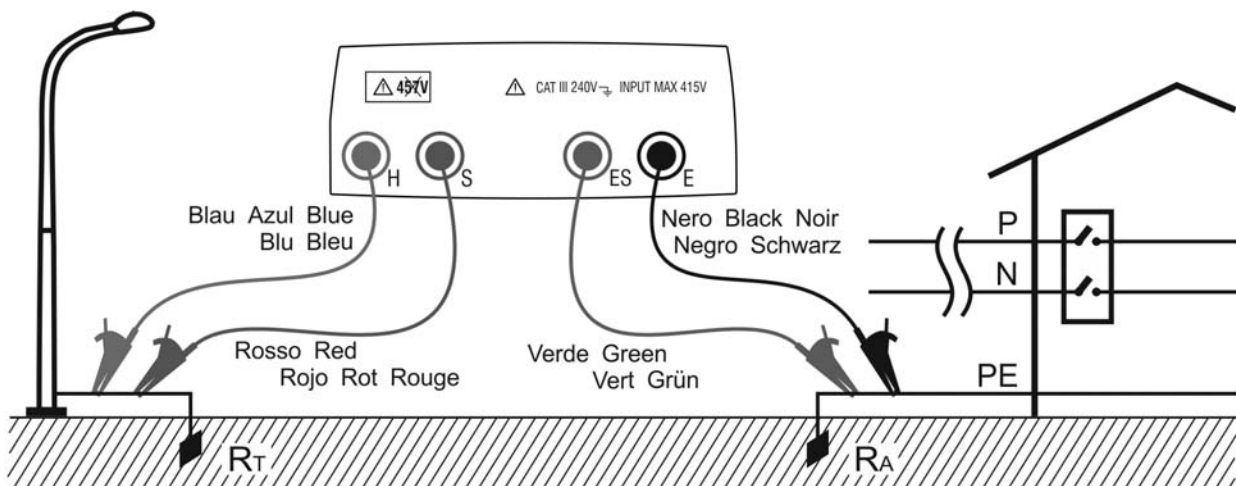

Fig. 4: Two-wire earth resistance measurement using an auxiliary rod

In the TT systems (see Fig. 5) it is possible to perform a two-wire earth measurement using the NEUTRAL conductor provided by the national Energy Board taken directly from a socket or panel board as an auxiliary rod; if also the earth connection is available, the measurement can be taken on the socket directly, between NEUTRAL and EARTH.

CAUTION



If you wish to effect the measurement using the neutral and earth conductors of an ordinary socket, you may accidentally connect to phase; in this case the detected voltage as well as the warning symbol for wrong entering will be displayed and no measurement will be effected even though the **GO** key is pressed

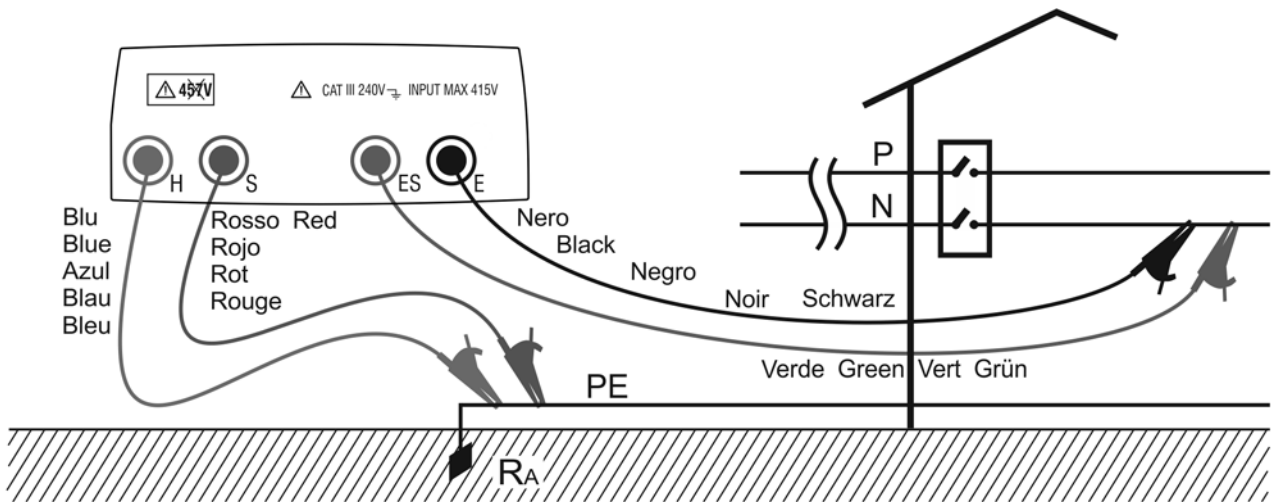
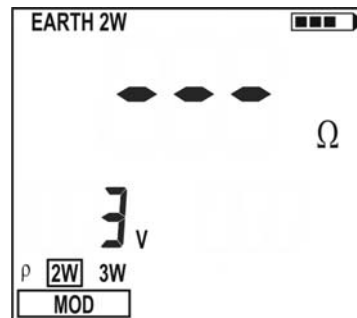

Fig. 5: Two-wire earth resistance measurement from the panel board

1. Turn the instrument on pressing the **ON/OFF** key
2. Pressing the right and left arrow keys \leftarrow , \rightarrow select **MOD**, then pressing the up and down arrow keys \blacktriangle , \blacktriangledown select **2W** option
3. A screen similar to the one beside appears where the input interfering voltage value of the instrument is displayed



4. Connect the blue, red, green and black cables to the corresponding instrument's input terminals H, S, ES, E then adding crocodiles if necessary
5. Extend, if necessary, the blue and red measuring cables separately using cables with proper section. Adding any extension does not require calibration and does not affect the measured earth resistance value
6. Connect crocodiles to the auxiliary rods and to the installation under test (see Fig. 4 and Fig. 5)
7. Press **GO** key, the instrument starts carrying out measurement

8. While the instrument is measuring a screen similar to the one beside appears where the instrument's input interfering voltage value is displayed. When the message **M**EAURING.... is displayed do not disconnect or touch the test leads

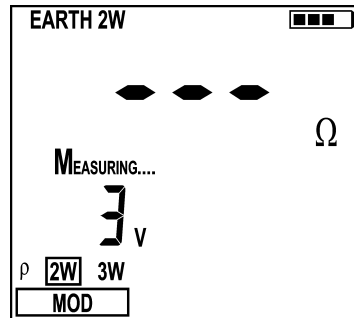

Input interfering voltage value

CAUTION



When starting measurement the input interfering voltage is measured at both the volt and ampere circuit. Should it range between 3 V and 9 V, the instrument carries out measurement and displays the symbol  indicating the uncertainty decline of the measurement (§ 9.1)

9. When the test is over, should the earth resistance value be lower than the full scale, the instrument emits a double tone indicating the positive outcome of the test and displays the resistance measurement as well as the interfering voltage value at the time of measuring

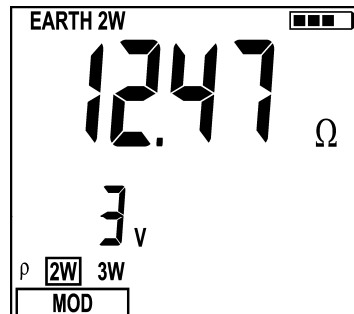

Earth resistance measurement

Input interfering voltage value

CAUTION



The resistance measurement is effected with 4-wire volt ampere method without being affected by the resistance value of the cables. It is therefore not necessary to effect compensation of cable resistance or of any extension

10. When the test is over, should the earth resistance value be higher than the full scale, the instrument emits a long tone indicating the negative outcome of the test and displays the screen beside

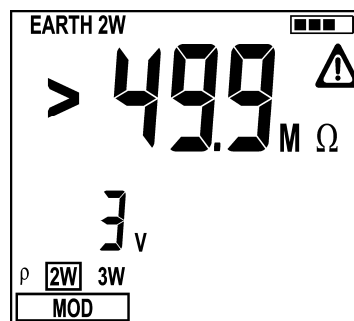

Earth resistance measurement higher than full scale

Input interfering voltage value

11.  The measurements can be stored pressing the **SAVE** key twice (§ 5.1)

4.5. ρ - GROUND RESISTIVITY MEASUREMENT

The ground resistivity value is an essential parameter to calculate the resistance value of the earth rods to be used for the earth installation's construction. The measurement is effected according to standards IEC 781, VDE 0413, IEC/EN61557-5.

CAUTION



- The instrument can be used for voltage and current measurements on installations with over voltage category equal to CAT III 240V to earth and maximum voltage of 415V between inputs. Do not connect the instrument to installations whose voltages exceed the limits indicated in this manual. Exceeding such limits may cause electric shock to the user and damage the instrument
- Always connect the cables to the instrument and to the alligator clips when the latter are not connected to the plant under test
- Always respect the Hand-held area of probe (see § 4.2)
- If the length of the supplied cables isn't suitable for the plant under test (see § 11), You can create your own extensions following indications in § 11.2.1

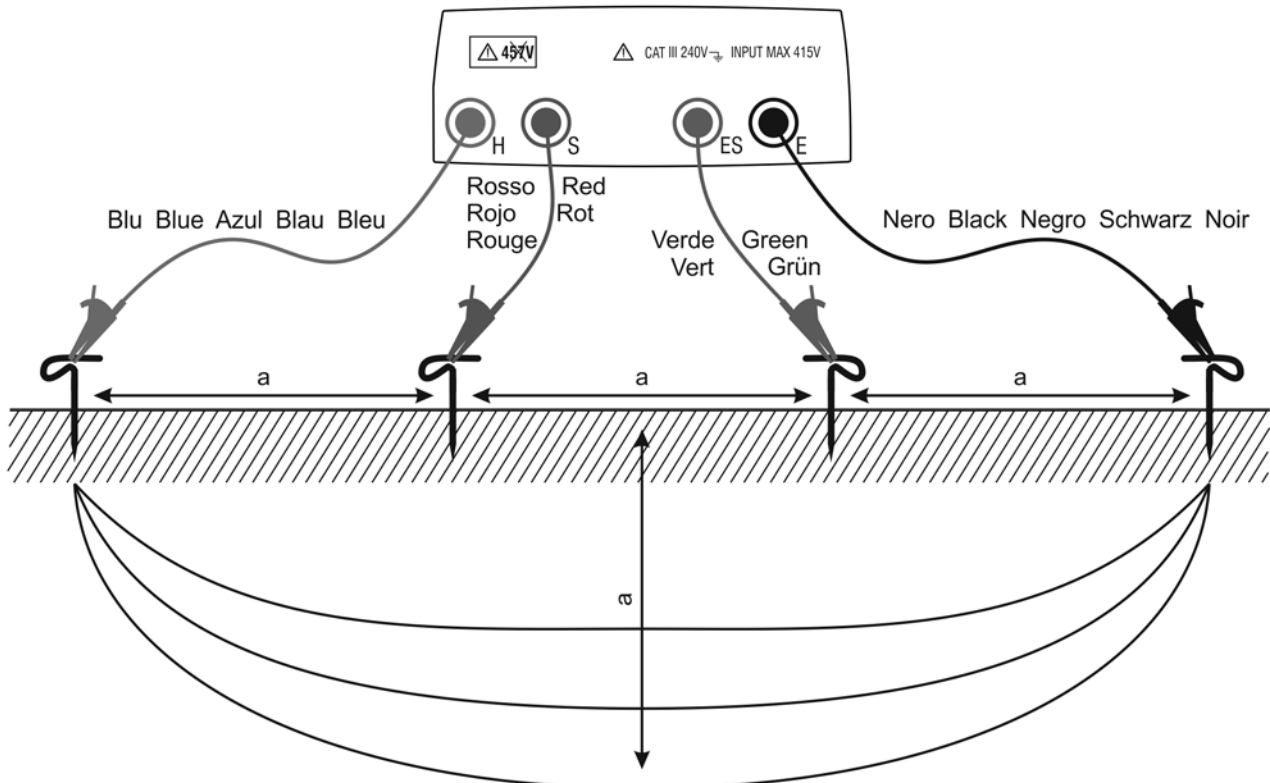
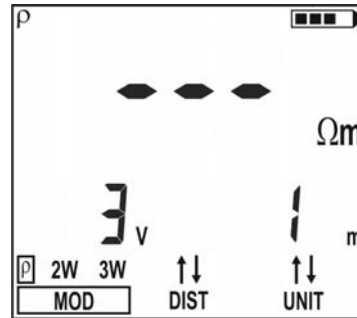



Fig. 6: Ground resistivity measurement

1. Turn on the instrument pressing the ON/OFF key
2. Pressing right/left arrow keys ◀, ▶ select **MOD**, then pressing up/down arrow keys ▲, ▼ select ρ option

3. A screen similar to the one beside appears where both the input interfering voltage of the instrument and the rods' distance value are displayed



Value of input interfering voltage and rods' distance set

4.  Should you need to modify the rods' distance press the arrow keys ◀, ▶ and select **DIST**, then pressing the arrow keys ▲, ▼ set the desired distance (ranging from 1 up to 10 metres, by steps of one or from 3 up to 30 feet by steps of three)

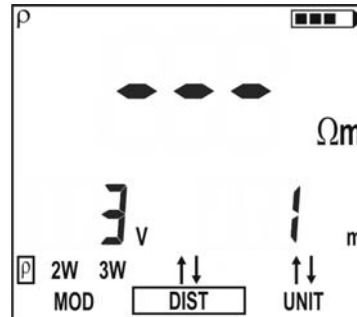

Value of rods' distance set

5.  To set the distance measuring unit press the arrow keys ◀, ▶ and select **UNIT**, then pressing the arrow keys ▲, ▼ set the desired measuring unit (m or ft)

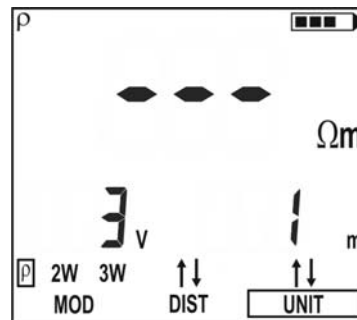

Measuring unit selected

6. Connect the blue, red, green and black cables to the corresponding instrument's input terminals H, S, ES, E then adding crocodiles if necessary
7. Extend, if necessary, the blue and red measuring cables separately using cables with proper section. Adding any extension does not require calibration and does not affect the measured ground resistivity value
8. Drive the auxiliary rods into the ground placing them on a line at a mutual distance equal to that selected on the instrument. Setting a distance other than the actual distance between the earth rods may affect the measurement (§11.3)
9. Connect crocodiles to the auxiliary rods (see Fig. 6)
10.  Press **GO** key, the instrument starts carrying out measurement

11. While the instrument is measuring a screen similar to the one beside appears where the instrument's input interfering voltage value and the distance set between auxiliary rods are displayed. When the message **MEASURING...** is displayed do not disconnect or touch the test leads

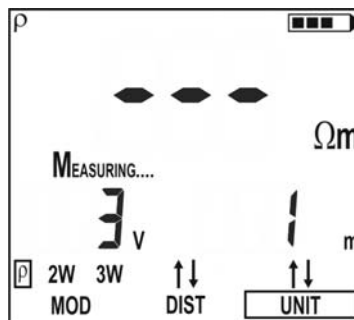

Value of input interfering voltage and rods' distance set

CAUTION



When starting measurement the input interfering voltage is measured at both the volt and ampere circuit. Should it range between 3 V and 9 V, the instrument carries out measurement and displays the symbol indicating the uncertainty decline of the measurement (§ 9.1)

12. When the test is over, should the ground resistivity value be lower than the full scale, the instrument emits a double tone indicating the positive outcome of the test and displays the resistivity measurement as well as the interfering voltage value at the time of measuring

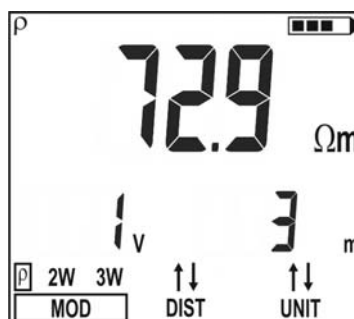

Measurement of ground resistivity

Value of input interfering voltage and rods' distance set

CAUTION



The resistivity measurement is effected with 4-wire volt ampere method without being affected by the resistance value of the cables. It is therefore not necessary to effect compensation of cable resistance or of any extension.

13. When the test is over, should the ground resistivity value be higher than the full scale, the instrument emits a long tone indicating the negative outcome of the test and displays the screen beside

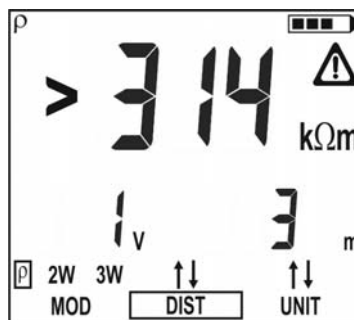

Measurement of ground resistivity higher than the full scale

Value of input interfering voltage and rods' distance set

CAUTION



The full scale is calculated as $\rho_{MAX} = 2 \pi \text{ DIST } R$ where DIST is the value set for the distance among the rods and R the maximum resistance value which can be measured by the instrument. The full scale of ground resistivity measurement depends on the setting of the distance among the rods

- 14.



The measurements can be stored pressing the **SAVE** key twice (§ 5.1)

4.5.1. Anomalous measuring applications

- When starting a measurement the instrument checks the continuity of measuring cables. **If the volt circuit (red cable S and green cable ES) is interrupted or its resistance value is too high**, the instrument displays a screen similar to the one beside. Check that terminals are properly connected and that the earth rod is connected to

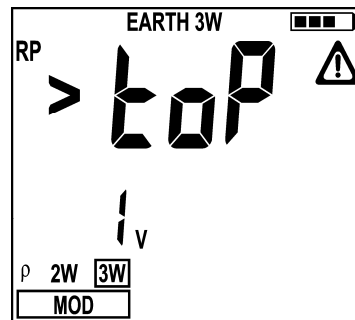

Volt circuit's resistance too high

Value of input interfering voltage

Example for 3W mode

terminal S and not driven into a pebbly or scarcely conductive ground. In this latter case pour water around the rod to decrease its resistance value (§ 11.2).

RP>top is displayed when:

- The S rod's resistance $R_s > 50K\Omega$ is summed up to the volt circuit
- The resistance of rod S exceeds the value $1200 + 100 R_x [\Omega]$ (where R_x is the earth resistance value)

- When starting a measurement the instrument checks the continuity of measuring cables. **If the ampere circuit (blue cable H and black cable E) is interrupted or its resistance value is too high**, the instrument displays a screen similar to the one beside. Check that terminals are properly connected and that the earth rod is connected to

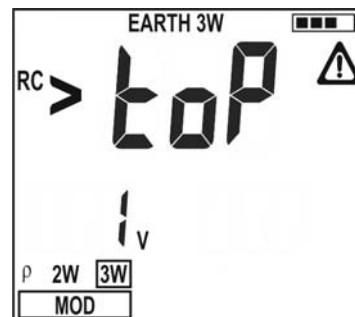

Ampere circuit's resistance too high

Value of input interfering voltage

Example for 3W mode

terminal H and not driven into a pebbly or scarcely conductive ground. In this latter case pour water around the rod to decrease its resistance value (§ 11.2).

RC>top is displayed when:

- The H rod's resistance $R_H > 50K\Omega$ is summed up to the ampere circuit
- The resistance of rod H exceeds the value $1200 + 100 R_x [\Omega]$ (where R_x is the earth resistance value)

- When starting a measurement the instrument checks the continuity of measuring cables. **If the volt circuit (red cable S and green cable ES) and the ampere circuit (blue cable H and black cable E) are both interrupted or their resistance values are too high**, the instrument displays a screen similar to the one beside. Check that the

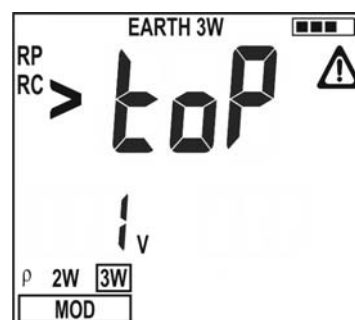

Both volt and ampere circuits' resistance too high

Value of input interfering voltage

Example for 3W mode

terminals are properly connected and that the earth rods connected to terminals S and H are not driven into a pebbly or scarcely conductive ground. In this latter case pour water around the rods to decrease their resistance value (§ 11.2).

RP, RC>top is displayed when:

- The S rod's resistance $R_s > 50K\Omega$ is summed up to the volt circuit and the H rod's resistance $R_H > 50K\Omega$ is summed up to the ampere circuit
- Both the S rod's resistance and the H rod's resistance exceed the value $1200 + 100 R_x [\Omega]$ (where R_x is the earth resistance value)

4. When starting a measurement, if the **red cable (connected to S terminal) and the green cable (connected to ES terminal) are reversed**, the instrument do not perform the test, emits a long sound tone and displays the screen beside

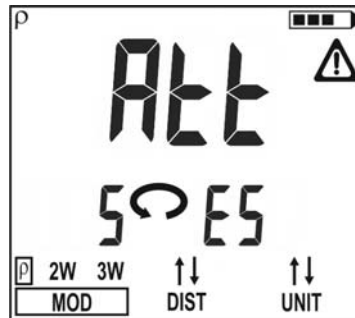

Red and green cables reversed

Example under ρ mode

5. When starting a measurement, if an **interfering voltage higher than 9V is detected at the volt circuit's input**, the instrument do not perform the test, emits a long sound tone and displays the screen beside

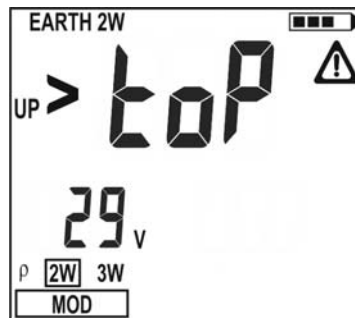

Too high input interfering voltage at volt circuit

Input interfering voltage value

Example under 2W mode

6. When starting a measurement, if an **interfering voltage higher than 9V is detected at the ampere circuit's input**, the instrument do not perform the test, emits a long sound tone and displays the screen beside

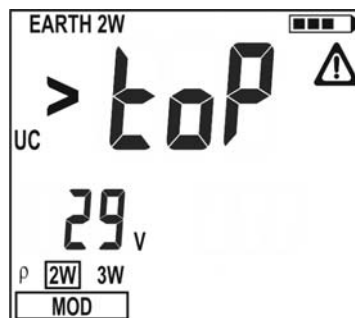

Too high input interfering voltage at ampere circuit

Input interfering voltage value

Example under 2W mode

7. When starting a measurement, if an **interfering voltage higher than 9V is detected at both the ampere and volt circuits' inputs**, the instrument do not perform the test, emits a long sound tone and displays the screen beside

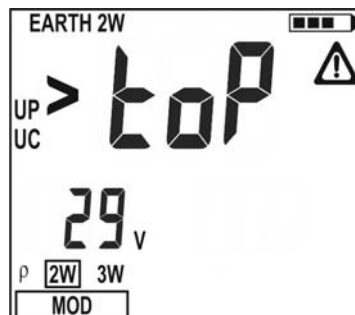

Too high input interfering voltage at both ampere and volt circuits

Input interfering voltage value

Example under 2W mode

8. If battery voltage is too low the instrument displays the symbol of low battery as well as the message **LOW BATT** and no measurement is allowed. It is however possible to carry out settings, reading of stored data, etc

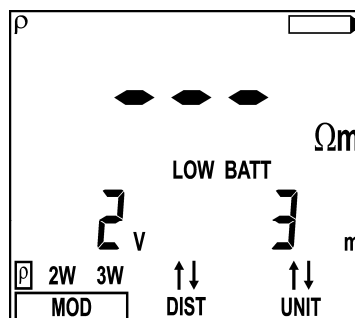

Too low power supply, low batteries

Input interfering voltage value and distance set among rods

Example under ρ mode

9.  The above said anomalous cases cannot be stored

5. MANAGEMENT OF STORED DATA

5.1. HOW TO SAVE A MEASUREMENT

- 

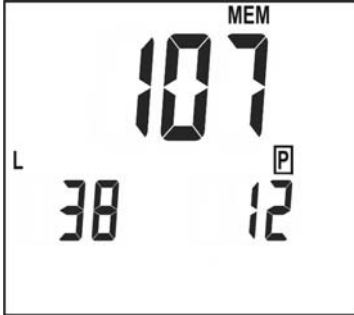

After taking a measurement press **SAVE** key, the instrument displays a screen similar to the one beside



No. of memory location where the measurement has to be saved
--

Last value set for parameters L and P

- 

Should you need to modify the values of the parameters L and P press the arrow keys ◀, ▶ and select L or P, then pressing the arrow keys ▲, ▼ set the desired value (from 1 to 255). These values can enable you to trace back the place where the measurement was effected
-  OR 

Confirm measurement storing pressing **SAVE** key or **ENTER** key

5.2. HOW TO CANCEL ONE OR SEVERAL MEASUREMENTS

- 

Press **RCL CLR** key, the instrument displays a screen similar to the one beside

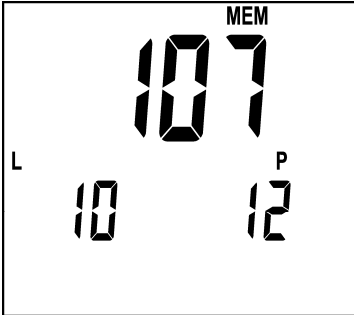

Number of the last memory location used

Values of L and P parameters

- 

Press the arrow keys ▲, ▼ to select the memory location where cancellation of data is to be started, the displays a screen similar to the one beside

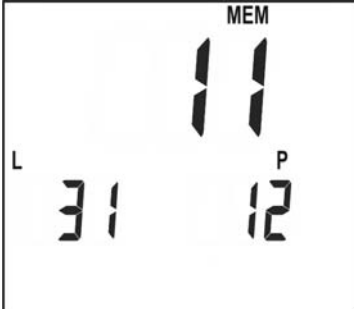

Number of the memory location where cancellation is to be started

Values of L and P parameters

CAUTION



Confirming cancellation of data causes removal of all stored data starting from the selected location till the last memory location

3.  Press the **CLR** key, the instrument displays a screen similar to the one beside

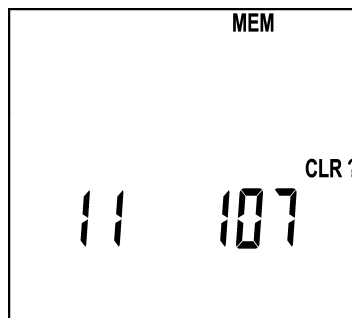

First and last memory location to be cancelled and confirmation required

Alternatively:

4.  Confirm cancellation of measurements pressing **ENTER** key, the instrument emits a double sound tone confirming cancellation of the selected measurements

Or:

4.  Press **ESC** key to go back to previous screen

5.3. HOW TO RECALL A MEASUREMENT

1.  Press the **RCL** key, the instrument displays a screen similar to the one beside

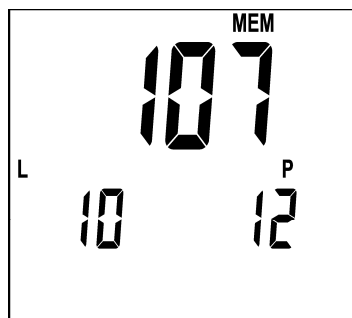

Number of the last memory location

Values of L and P parameters

2.  Press the arrow keys **▲**, **▼** to select the memory location whose content is to be displayed

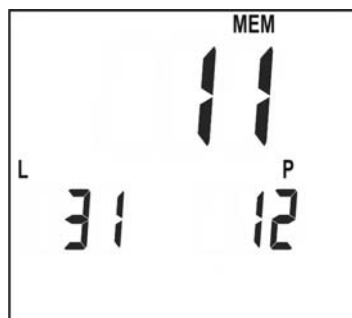

Number of the memory location whose content is to be displayed

Values of L and P parameters

3.  Press the **ENTER** key to display the measurement stored inside the selected memory location, the instrument displays a screen similar to the one beside

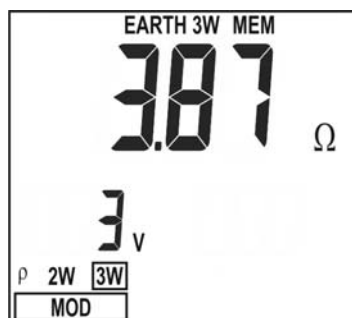

Measurement stored in the selected memory location

Values of interfering voltage at measurement

4.  Press the **ESC** key to go back to previous screen and press the **ESC** key again to exit the memory management

6. INSTRUMENT RESET

CAUTION



BEFORE CARRYING OUT THE INSTRUMENT'S RESET SAVE ALL DATA RELATIVE TO THE MEASUREMENTS EFFECTED BY DOWNLOADING THEM TO A PC

- 
 When the instrument is off press the **RCL/CLR** key

- 
 Keeping down the **RCL/CLR** key, press the switch on key. The instrument emits a short sound tone showing all display segments for approx. 1 second. Then it emits a second short sound tone displaying the screen beside for approx. 3 seconds

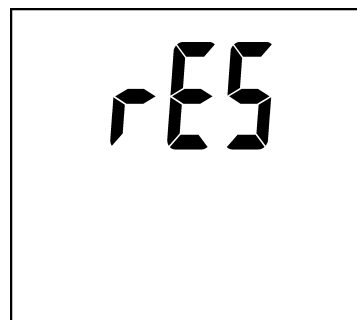

CAUTION



The HARD RESET procedure deletes all data previously stored and the parameter DST resumes its default value (1 m or 3 ft)

7. INSTRUMENT CONNECTION TO PC

The instrument can be connected to a PC by means of the serial port or USB and opt insulated cable provided along with the software package. First it's necessary to select the COM port used for the transmission and the correct baud rate (9600 bps). To set these parameters install the software and consult the help on line.

The selected port shall be free of any other device or application such as mouse, modem, etc.

CAUTION



Optical port emits Laser radiations , Don't locate beam at eye level. Class 1M laser apparatus according to EN 60825-1

To transfer stored data to PC keep to the following procedure:

- 
 Turn on the instrument pressing the power key
- Connect the instrument to a PC by means of the opt insulated cable provided with the software package. **Communication is enabled at any function except for measurements as well as when memory management is active (§ 5)**
- Use the data management software to download the instrument's stored data to a PC. During the data transfer the instrument displays a screen as beside, then after completing the data transfer goes back to the previously selected mode

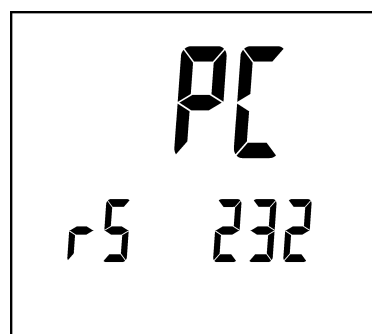

8. MAINTENANCE

8.1. GENERAL

This is a precision instrument. Strictly follow the instructions for use and storage reported in this manual to avoid any possible damage or danger during use.

Do not use this tester under unfavorable conditions of high temperature or humidity. Do not expose to direct sunlight.

Be sure to turn off the tester after use. If the instrument is not to be used for a long period you are recommended to remove batteries to avoid leakages of battery liquid which may damage its internal circuits.

8.2. BATTERY REPLACEMENT

When the low battery indication (see § 9.1.2) is displayed the batteries are to be replaced.



CAUTION

Only skilled technicians can open the instrument and replace batteries. Before removing batteries disconnect all cables from input terminals

1. Turn off the instrument pressing the ON/OFF key for a while
2. Disconnect the cables from the input terminals
3. Remove the battery cover screws and detach the battery cover
4. Replace batteries with new ones of the same type (see § 9.1.2) keeping to the right polarity signs
5. Replace cover and screws
6. Use the appropriate battery disposal methods for your area

8.3. INSTRUMENT CLEANING

Use a soft dry cloth to clean the instrument. Do not use wet clothes, solvents, water etc.

8.4. END OF LIFE



Caution: this symbol indicates that equipment and its accessories shall be subject to a separate collection and correct disposal.

9. TECHNICAL SPECIFICATIONS

9.1. TECHNICAL FEATURES

Accuracy indicated as [%reading + (number dgts * resolution)] at $23 \pm 5^{\circ}\text{C}$, <80%RH

3- and 2-wire earth resistance measurement - EARTH 3W and EARTH 2W

Measurement range (**)		Resolution [Ω]	Accuracy (*)
Reading [Ω]	Measure [Ω]		
0.01 ÷ 19.99	0.08 ÷ 19.99	0.01	$\pm(2.5\%rdg + 2dgt)$
20.0 ÷ 199.9	20.0 ÷ 199.9	0.1	
200 ÷ 1999	200 ÷ 1999	1	
2.00 ÷ 19.99k	2.00 ÷ 19.99k	0.01k	
20.0 ÷ 49.9k	20.0 ÷ 49.9k	0.1k	

Ground resistivity measurement - ρ (distance among the rods=1m)

Range (**)		Resolution [Ωm]	Accuracy (*)
Reading [Ωm]	Measure [Ωm]		
0.06 ÷ 19.99	0.50 ÷ 19.99	0.01	$\pm(2.5\%rdg+2dgt)$
20.0 ÷ 199.9	20.0 ÷ 199.9	0.1	
200 ÷ 1999	200 ÷ 1999	1	
2.00 ÷ 19.99k	2.00 ÷ 19.99k	0.01k	
20.0 ÷ 199.9k	20.0 ÷ 199.9k	0.1k	
200 ÷ 314k	200 ÷ 314k	1k	

- Measuring frequency: 77.5Hz; Test current: $\leq 12\text{mA}$; Open loop voltage: $< 25\text{Vrms}$
- Disturbance voltage on ampere and volt circuits: the measurement is taken with the stated accuracy if the interfering voltage is $\leq 3\text{V}$, while for interfering voltages ranging from $> 3\text{V}$ and $\leq 9\text{V}$, the accuracy decreases progressively; with an interfering voltage equal to 9V the instrument does not perform the test

(*) If $R_P > 1200 + 100 R_X$ and/or $R_C > 1200 + 100 R_X$, $R_P > 50\text{k}\Omega$ and/or $R_C > 50\text{k}\Omega$ and the instrument carries out the test, the accuracy of the instrument is $\pm(10\% \text{ reading})$ where:

R_P = resistance of the voltage circuit; R_C = resistance of the current circuit; R_E = measured earth resistance

(**) Automatic selection of the range

Interfering voltage measurement

Range (**)		Resolution [V]	Uncertainty
Reading [V]	Measure [V]		
0 ÷ 460	7 ÷ 460	1	$\pm(2.0\%rdg+2dgt)$

(**) Automatic selection of the range

9.1.1. Reference standards

Safety:	IEC/EN61010-1, IEC/EN61557-1, IEC/EN61557-5
Measuring accessories' safety:	IEC/EN61010-031
Technical literature:	IEC/EN61187
Insulation:	double insulation
Mechanical protection:	IP50 according IEC/EN60529
Pollution level:	2
Measurement category:	CAT III 240V (to earth), maximum 415V between inputs
Max height of use:	2000m (6562ft)

9.1.2. General features

Mechanical features

Dimensions (L x W x H):	235 x 165 x 75mm (9 x 6 x 3in)
Weight (including batteries):	1kg (2lv)

Power supply

Battery type:	6x1.5V batteries type AA LR6 or 6x1.2V rechargeable batteries NI-MH AA LR6 2100mA
Low battery indication:	symbol "▢" is displayed
Battery life:	approx. 500 tests
Auto Power OFF:	after 3 min of idleness

Display

Features:	LCD custom with back-light 73x65 mm
-----------	-------------------------------------

Memory

Features:	999 memory locations
-----------	----------------------

PC connection

Features:	optoinsulated port for bi-directional communication
-----------	---

9.2. ENVIRONMENT

9.2.1. Operating environmental conditions

Reference calibration temperature:	23 ± 5°C (73 ± 41°F)
Working temperature:	0 ÷ 40°C (32°F ÷ 104°F)
Maximum relative humidity:	<80%RH
Storage temperature:	-10 ÷ 60°C (14°F ÷ 140°F)
Storage humidity:	<80%RH

<p>This instrument complies with the requirements of the European Low Voltage Directive 2006/95/CE (LVD) and EMC Directive 2004/108/CE</p>

9.3. ACCESSORIES

9.3.1. Standard and optional accessories GEO416

See enclosed packing list

9.3.2. Standard accessories GEO416GS

• Set of 4 cables, banana-banana, L=1m	KIT416CV
• Set of 4 alligator clips	COC4-UK
• Carrying bag	BORSA2000N
• ISO9000 calibration certificate	
• User manual	

10. SERVICE

10.1. WARRANTY TERMS

This instrument is guaranteed against material or manufacturing defects, in accordance with general sales conditions. During the warranty period the manufacturer reserves the right to decide either to repair or replace the product.

Should you need for any reason to return back the instrument for repair or replacement take prior agreements with your local distributor. Freight charges are up to the customer. Do not forget to enclose a report describing the reasons for returning the unit as well as the detected fault.

Use only original packaging. Any damage occurred in transit due to no-original packaging will be charged anyhow to the customer.

The manufacturer will not be responsible for any damage to persons or things.

The warranty doesn't apply to the following cases:

- Repair and/or replacement of accessories and batteries (not covered by warranty)
- Repairs made necessary due to improper use (including adaptation to particular applications not foreseen in the instructions manual) or improper combination with incompatible accessories or equipment
- Repairs made necessary due to improper shipping material causing damages in transit
- Repairs made necessary due to previous attempts for repair carried out by unskilled or unauthorized personnel
- Instruments for whatever reason modified by the customer himself without explicit authorization of our Technical Dept
- Use not provided by the instrument's specifications or in the instruction manual.

The contents of this manual may not be duplicated in any form whatsoever without the manufacturer's authorization.

Products are patented and logotypes registered. The manufacturer reserves the right to modify specifications and prices in view of technological improvements or developments which might be necessary.

10.2. AFTER-SALES SERVICE

Shouldn't the instrument work properly, before contacting your distributor make sure that batteries are correctly installed and working, check the test leads and replace them if necessary.

Make sure that your operating procedure corresponds to the one described in this manual.

Should you need for any reason to return back the instrument for repair or replacement take prior agreements with your local distributor. Freight charges are up to the customer. Do not forget to enclose a report describing the reasons for returning the unit as well as the detected fault.

Use only original packaging. Any damage occurred in transit due to no-original packaging will be charged anyhow to the customer.

The manufacturer will not be responsible for any damage to persons or things.

11. PRACTICAL REPORTS FOR ELECTRICAL TESTS

11.1. EARTH RESISTANCE IN TT SYSTEMS

The test is aimed at checking that the RCD is coordinated with the earth resistance value. It is not possible to assume an earth resistance value as reference limit when controlling the test result, while it is necessary to check every time that the co-ordination complies with the requirements of the Standards.

The parts to be checked are represented by the whole earth installation under working conditions. The check is to be effected without disconnecting the earth rods.

The earth resistance value measured shall meet the following relation $R_A < 50 / I_a$ where:

R_A = resistance of the earth installation whose value can be set with the following measurements:

- Three-wire earth resistance with volt ampere method
- Two-wire earth resistance with volt ampere method
- Phase to earth fault loop impedance (*)
- Two-wire earth resistance in the socket with volt ampere method (**)
- Earth resistance obtained by the measurement of contact voltage U_t (**)
- Earth resistance obtained by the tripping time test of the RCDs (A, AC), RCD S (A, AC) (**)

I_a = tripping current in 5s of the automatic RCD; rated tripping current of the RCD (in case of RCD S $2 I_{\Delta n}$) in ampere

50 = safety limit voltage (reduced down to 25V in special environments)

(*) If the installation is protected by an RCD the measurement shall be effected upstream or downstream the RCD short-circuiting it to avoid its tripping

(**) This method, even though not presently provided for by standards, provide values, which compared with numberless reference 3-wire tests resulted to be reliable for earth resistance

Example

Let's assume an installation protected by an RCD $I_a = 30$ mA. The earth resistance is measured using one of the methods quoted above. To evaluate whether the installation resistance is complying with the standards in force multiply the result by 0.03A (30 mA). If the result is lower than 50V (or 25V for special environments) the installation can be considered as coordinated as it meets the above said relation.

In case of 30 mA RCDs (most civil installations) the maximum earth resistance allowed is $50 \text{ V} / 0.03 = 1666\Omega$ permitting to use even simplified methods which though do not provide extremely accurate values, give values approximate enough to calculate the coordination.

11.2. EARTH RESISTANCE, VOLTAAMPEREMETRIC METHOD

11.2.1. Creating cables extensions

If the length of the supplied cables isn't suitable for the plant under test, You can create your own extensions without influencing the instrument's accuracy.

For your own safety and to avoid damaging the instrument you are recommended to respect the following indications:

- Always use cable characterized by Insulation voltage and Insulation class complying to Nominal voltage and measurement category (Overvoltage) of the plant under test
- Always use terminal connectors characterized by measurement category (Overvoltage) and Nominal voltage complying to Nominal voltage of the plant under test (see § 1.4). It is recommended the **1066-IECN** optional accessory

11.2.2. Method for small-sized earth rods

Let a current stream between the earth rod under test and an auxiliary probe placed at a distance equal to fivefold the diagonal of the area limiting the earth installation itself. Place the voltage probe at approximately half way between the earth rod and the current probe, finally measure voltage between both of them.

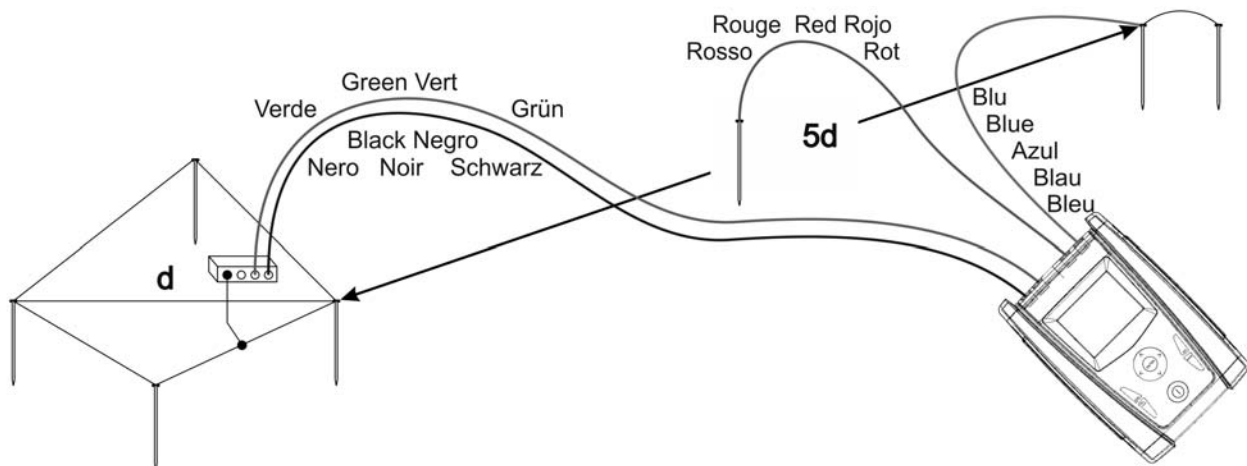

Fig. 7: Earth resistance measurement – small-sized earth rods

11.2.3. Method for large-sized earth rods

This procedure is based on the volt ampere metric method as well, however it is mainly used whenever it is difficult to place an auxiliary current rod at a distance equal to fivefold the diagonal of the area limiting the earth installation. **Place the current probe at a distance equal to the diagonal of the earth installation.** To make sure that the voltage probe is placed outside the area affected by the rod under test as well as the auxiliary rod, take several measurements, firstly placing the voltage probe at half way between the installation and the auxiliary current probe, later moving the probe to both the installation under test and the auxiliary current probe. Such measurements shall give compatible results, any difference among measurement values taken indicates that the voltage rod was driven within the influence area of the installation under test or of the auxiliary current rod. Such measurements cannot be considered as reliable.

In this instance it is necessary to further extend distance between the auxiliary current rod and the rod under test, then repeat the whole procedure as above described.

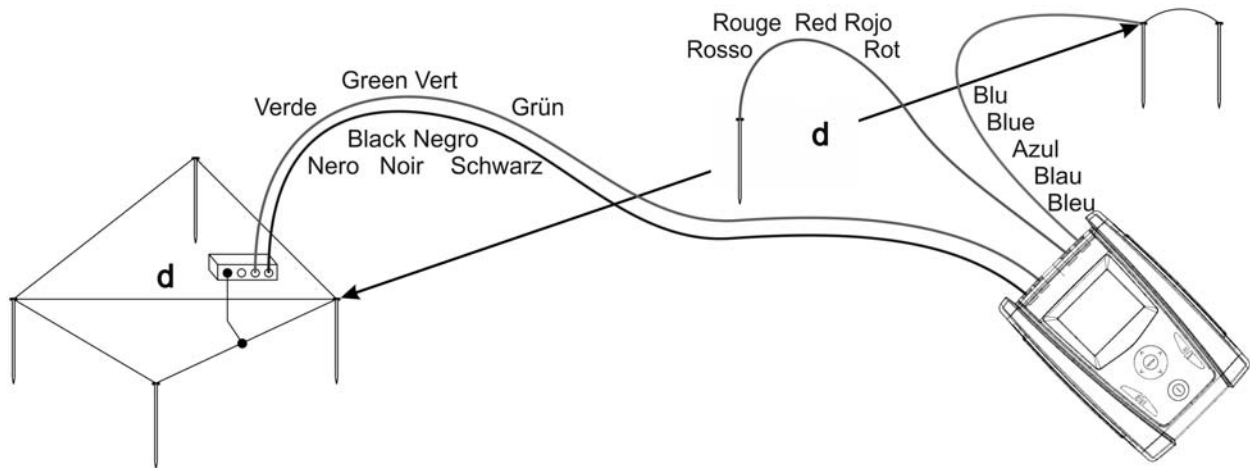

Fig. 8: Earth resistance measurement – large-sized earth rods

11.3. GROUND RESISTIVITY

This test aims at analyzing the resistivity value of the ground in order to define the type of rods to be used when designing the installation. For the resistivity test correct or not correct values do not exist. The various values measured by positioning the rods at growing distances “a” must be quoted in a graph. According to the resulting curve, suitable rods will be chosen. As the test result can be affected by metal parts buried such as pipes, cables or other rods etc., it is advisable in case of doubts to take a second measurement positioning the rods at an equal distance “a”, but rotating their axis by 90°.

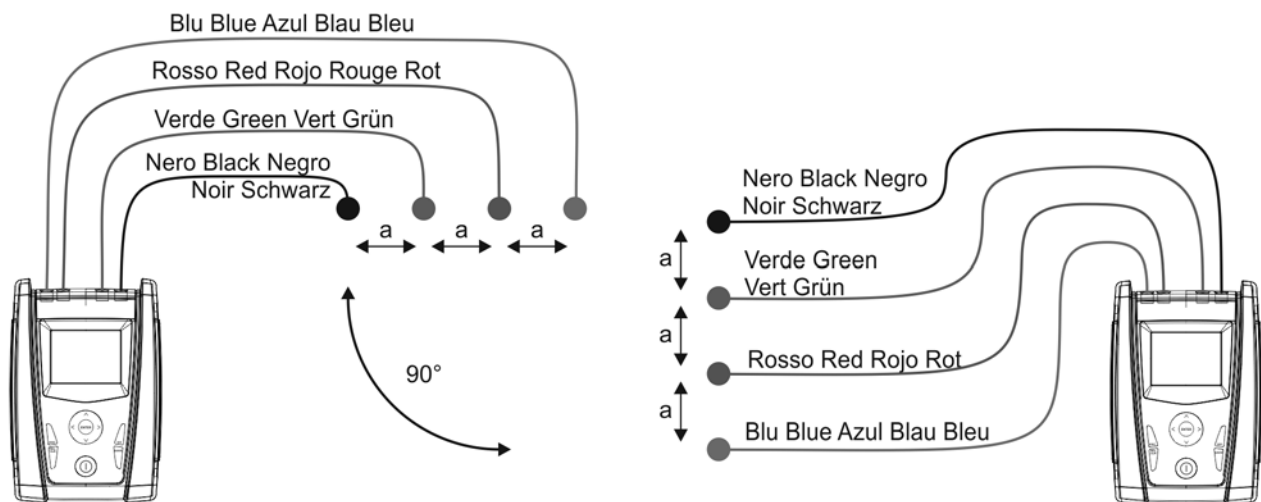
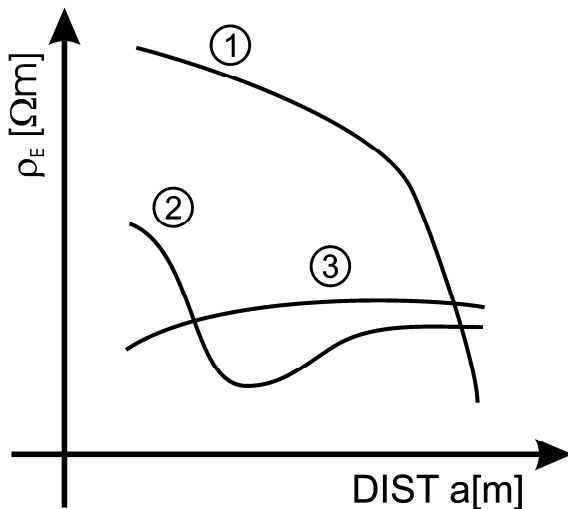

Fig. 9: Measurement of ground resistivity

The resistivity value is given by the following relation: $\rho_E = 2 \pi a R$ where:

- ρ_E = ground resistivity
- a = distance between probes [m]
- R = resistance measured by the instrument [Ω]

The measuring method allows defining the specific resistivity of a ground layer up to the depth corresponding approximately to the distance “a” between the rods. If you increase the distance “a” you can reach deeper ground layers and check the ground homogeneity. After several measurements you can trace a profile according to which the most suitable rod is chosen.



- Curve 1:** as ρ_E decreases only in depth, it's advisable to use a very deep rod
- Curve 2:** as ρ_E decreases only until the depth a, it's not useful to increase the depth of the rod beyond a
- Curve 3:** the ground resistivity is quite constant, so increasing depth does not make ρ_E decrease, therefore a ring rod must be used

Fig. 10: Measurement of ground resistivity

11.3.1. Approximate evaluation of intentional rods' contribution

The resistance of a rod R_d can be calculated with the following formulas (ρ = average resistivity of the ground).

a) resistance of a vertical rod

$$R_d = \rho / L$$

where L = length of the element touching the ground

b) resistance of an horizontal rod

$$R_d = 2\rho / L$$

where L = length of the element touching the ground

c) resistance of linked elements

The resistance of a complex system made of more elements in parallel is always higher than the resistance, which could result from a simple calculation of single elements in parallel, especially if those elements are close to each other and therefore interactive. For this reason, in case of a linked system the following formula is quicker and more effective than the calculation of the single horizontal and vertical elements:

$$R_d = \rho / 4r$$

where r = radius of the circle which circumscribes the link



Via della Boaria 40
48018 – Faenza (RA) - Italy
Tel: +39-0546-621002 (4 linee r.a.)
Fax: +39-0546-621144
Email: ht@htitalia.it
Web :www.ht-instruments.com